



**HIGH
TEMPERATURE
MATERIALS
and
ADHESIVES
FOR USE
TO 3000°F**

COTRONICS

CORP.

SINCE 1971

HIGH TEMP. MATERIALS INDEX

HIGH TEMPERATURE EPOXIES

Description	Temp.	Cat. No.	Page
Epoxy Adhesive Property Table			36
Adhesive and Tooling Compound	700°F	4703	8
Electrically Resistant, All Purpose	500°F	4525	5
Electrically Conductive Adhesives	400-650°F	120-127	10-11
Epoxy Aids: Thinner, Flexibilizer, etc.		105	22
Epoxy-EEZ Pre-Measured Kits	450-600°F		19
Epoxy-EEZ Twin Pack Cartridges	500°F	EETP	18
Fast Setting Adhesives	450°F	7056 AL	17
Flexible Epoxy (Variable Flexibility)	500°F		9
Liquid Aluminum Adhesive	500°F	4540	17
Low Expansion Adhesive	500°F	4463	15
Low Viscosity Adhesive, Potting CPD	500°F	4461	7
Low Viscosity, Ultra Temp. Adhesive	600°F	4460	6
Non Magnetic Adhesives	500-600°F	NM25, HT	14
Nylon Bonder	400°F	7050	15
One Component, Electrical Resistant	450°F	4420	16
One Component, Structural Adhesive	400°F	455	16
Potting Compounds	450-650°F	861-868	20-21
Sterilizable Adhesive and Sealant	500°F	S5H13	15
Super Bonder	400°F	007	14
Thermally Cond., Electrically Resist.	400°F	4400	14
Thermally Conductive Adhesives	500-600°F	128-135	12-13
Ultra Temperature Adhesives	600°F	4700	8
Directions for Epoxy Adhesives			64

SILICON ADHESIVES

Description	Temp.	Cat. No.	Page
Clear, Thin, Spreadable Putty	650°F	1532	23
Five Minute, Casting Compound	550°F	1533	23
Non Sag, High Temp. Caulking Cpd.	800°F	1531	23

CERAMIC ADHESIVES

Description	Temp.	Cat. No.	Page
Ceramic Adhesive Comparison Table			24
Selector Kits		970N	25
Adhesive and Sealant Putty	2300°F	907GF	38
All Purpose, Fire Proof Adhesive	2300°F	907	30
Alumina Adhesive	3000°F	989, F, FS	27
Alumina, High Purity Adhesive	3250°F	930HP	26
Electrically Resistant Adhesive	2800°F	919	29
Fast Set Adhesives	2000-2800°F	940	31
Graphite Adhesive & Coating	2500-5400°F	931, 931C	32
High Expansion, Epoxy Like Adh.	1800°F	7030	30
High Expansion, High Temp. Adh.	3000°F	906	28
Low Expansion Adhesive	2500°F	905	28
Metalic Composite Adhesives	1200-2000°F	950, 952, 954	33
Moisture Proof, Alumina Adhesive	3000°F	908	26
Potting Compounds	3000°F	801-820	34-35
Thermally Cond., Electrically Resistant ..	3000°F	920	29
Ultra Temp. Zirconia Adhesive	4000°F	904	32
Directions for Ceramic Adhesives			64

CERAMIC SEALERS

Description	Temp.	Cat. No.	Page
Duraseal Silicone Sealants	1800°F	1529	36

HIGH TEMP COATINGS

Description	Temp.	Cat. No.	Page
Electrically Resistant Coating	2500°F	215	36
Heat Resistant Paint	1200°F	201	36
Stainless Steel/Porcelain Coating	1800°F	254	36
Stainless Steel Heat/Corrosion Paint	1500°F	230N	36

HIGH TEMPERATURE PUTTIES

Description	Temp.	Cat. No.	Page
All Purpose Adhesive, Sealant Putty	2300°F	907GF	38
Aluminum, High Temp. Putty	1000°F	7025	39
Aluminum Repair Kits	500°F	Rk454, 454B	39
Ceramic, Insulation Putty	2300°F	7020	51
Stainless, High Temp Putty	2000°F	7032	39
Stainless Steel Repair Kits	500°F	Rk456, 456B	39

HIGH TEMP SUPPLIES

Description	Temp.	Cat. No.	Page
Aluminum Spray Coating	1000°F	201SP	37
Anti-Seize	2400°F	R450	37
Braze Binder		4B, 4BE	40
Boron Nitride Coating & Lubricant	1500°F	112	37
Disposable Dispensers		108	22
High Temperature Specialty Tapes	600°F	600-650	40
Stainless Spray & Brush On Coating	1200°F	6105SP	37
Thermal Boards	3000°F	7011	40
Thread Lockers	-300-2100°F	907TS	41
Aluminum Spray Coating	1000°F	201SP	37

FLEXIBLE CERAMICS & INSULATION PRODUCTS

Description	Temp.	Cat. No.	Page
Ceramic Adhesive, Fiber Based	2300°F	901	51
Ceramic Blanket	3000°F	370	42
Ceramic Board	2500°F	360	45
Ceramic Fiber Tape	2500°F	390	47
Ceramic Paper	3000°F	300	43
Ceramic Putty	2300°F	7020	51
Insulating and Gasketing Ropes	2300°F	395R, 396HT	50
Kevlar - Aramid Products	650°F	398	46
Liquid Insulation Rigidizer, Hardener	3000°F	901A	50
Moldable Wet Felts	2300°F	372	44
Silica Tapes, Sleeving, Cloths	3000°F	399	46
Thermal Stop, Foil Black Tapes	2300°F	375FT	44
Ultra Temp., Woven Tapes & Cloths	2600°F	391	48
Woven Tapes, Sleeving, Cloths	1100°F	395	49
Woven Tapes, Sleeving Cloths	1500°F	397	49

MACHINABLE CERAMICS

Description	Temp.	Cat. No.	Page
Machinable Ceramics Comparison Table			52
96% Alumina	3000°F	960	55
99.8% Alumina	3100°F	961	54
Alumina Silicate	2100°F	902	53
Alumina Silica Foam Block	2600°F	311	58
Fused Silica Foam Block	3000°F	310M	58
Glass	800°F	914	57
Graphite	3000°C	56L	56
Macor	1800°F	915	56

CASTABLE CERAMICS

Description	Temp.	Cat. No.	Page
Insulating Ceramic Foam	2300°F		59
Fused Silica, Zirconia Oxide, Silicon Carbide, Alumina Oxide	4000°F	740-780	60-61
Mold Making Material	200°F	101	62
Mold Releases	625°F	101MR	62
Directions for Casting Ceramics			63

HELPFUL INFORMATION

Conversion Tables	66
Terms and Conditions	2

High Purity Materials and Custom Formulations
Available on Request

COTRONICS' HIGH TEMPERATURE EPOXY-BASED ADHESIVE PROPERTIES

FEATURES	CONDUCTIVE		500°F ROOM TEMP. CURES			600°F ULTRA TEMP			MACHINABLE		ONE PART	
	120	132	4461	4525	4538	7050	4460	4700	4703	4540	454B	4420
Properties	Super Electrical Conductive	High Thermal Conductive	Low Viscosity Adhesive and Coating	General purpose Adhesive and Potting	Super Flexible Stress Free Adhesive	Nylon Bonder Bonds Most Surfaces	Hi-Temp. Low Viscosity and Coating	Hi-Temp Gen. Purpose Adhesive and Casting	Ultra Temp. Tooling Repairs	Machinable Aluminum Casting and Repairs	Machinable Non-Sag Putty Adhesive	One Component Structural
Maximum Temp	500°F	500°F	500°F	500°F	450°F	450°F	600°F	600°F	650°F	500°F	450°F	450°F
Components - Color	2-Silver	2-Silver	2-Amber	2-Black	2-Tan	2-Black	2-Amber	2-Black	2-Black	2-Silver	2-Silver	1-Grey
Viscosity (cps)	25,000	36,500	600	25,000	10,000	20,000	600	40,000	50,000	30,000	100,000	Paste
Density (gm/cc)	3.8	1.8	1.1	1.7	1	1.3	1.1	1.8	1.8	1.9	1.9	1.2
Hardness (Shore 'D')	70	75	90	90	60-80A	70	90	94	95	80	80	75
Tensile Strength (psi)	6,500	7,200	9,500	10,000	6,000	5,000	10,300	11,100	11,800	10,000	10,000	7,000
Thermal Cond. (BTU-in./Hr. F ² /°F)	50	40	4	13	7	4.5	4	13	18	35	35	8
Thermal Expansion (x 10 ⁻⁵ /°C)	4.1	4.1	5.4	3.3	N/A	4.8	5.4	3.4	3.9	4.1	4.1	3.3
Dielectric Strength (volts/mil)	N/A	100	450	450	450	400	500	550	450	100	100	400
Volume Resistivity (ohm-cm)	0.00008	10 ⁶	10 ¹³	10 ¹⁵	10 ¹⁴	10 ¹⁴	10 ¹⁴	10 ¹⁴	10 ¹⁰	10 ⁸	10 ¹⁰	10 ¹⁰
Heat Distortion	210°C	210°C	210°C	210°C	75°C	75°C	260°C	300°C	320°C	225°C	200°C	175°C
Elongation (%)	0.2	0.2	5	2	12-100	3	5	2	2	1.2	1.2	1.5
Thermal Stability (%) (1000 hr. @ 200°C)	0.2	0.2	0.2	0.05	0.5	0.5	0.1	0.1	0.02	0.5	0.5	0.6
Shrinkage (% max.)	0.2	0.8	0.8	0.2	0.8	0.8	0.5	0.2	0.1	0.1	0.2	0.3
Moisture Absorption (% 30 days)	0.2	0.2	0.15	0.1	0.5	0.2	0.1	0.02	0.15	0.2	0.2	0.5
Mix Ratio (by weight)	100/3.4	100/27	100/17	100/8	100/120	100/10	100/80	100/28	100/22	100/9	100/11	N/A
Working Time for 25 gms. (Mins. @ 75°F)	30	30	30	30	90	30	N/A	N/A	N/A	30	30	N/A
Cure (Hr. @ 75°F)	16-24	16-24	16-24	16-24	16-24	4-16	N/A	N/A	N/A	16-24	16-24	N/A
Cure (Mins. @ 250°F)	7	5	5	5	60	1-2	4 Hrs.	4 Hrs.	4-6 Hrs.	8	10	30
Page No.	10	12	7	5	9	15	6	8	8	17	39	16

Pre-Measured Kits

Epoxy-Eez in 10 gm. and 25 gm. units see page 19

500°F ELECTRICALLY RESISTANT EPOXY

Cures at Room Temp. to Bond, Pot, Seal and Protect

500°F - DURALCO™ 4525 & 4525IP

Easy to use. Just mix and apply.

No volatiles. No solvents. No out-gassing.

Duralco 4525 cures at room temp. (or in 5 minutes at 250°F) to provide high bond strength, high temp. stability, low shrinkage, excellent chemical, electrical and radiation resistance and low moisture absorption.

It maintains its high electrical resistance over long periods of time and has the lowest moisture absorption available when compared to 23 commercially available epoxies. (This application has been approved by UL).

Duralco 4525 is ideal for high performance bonding, potting, sealing, repairs, castings and jigs. Forms protective coatings.

Commonly found in electronics, appliances, instrumentation, motors, equipment, etc.

Users Report:

High Resistance Even in High Humidity

Used to seal thermocouples, electric heaters and critical electronic components for use in high humidity environments. Tests show less than 10% of the moisture transmission of silicones or competitive epoxies.

Proven in Instrumentation Applications

Used for fabrication of end seals and installation of thermocouples, pressure, strain gauges and flow measuring instruments.

Excellent Corrosion Resistance

Used to repair glass lined tanks for use in 36% Hydrochloric, 29% Phosphoric, 65% Sulfuric and 70% Nitric Acids, 25% Caustic, 30% Chrome Oxide solutions. Competitive epoxies disintegrated in less than 24 hours.

Bonds Carbon to Steel and Remains in use for 5 years

Used to bond carbon blocks to steel for bearings in a rotating kiln at 300°F. Bonds brake pads.

Fast Cures

Independent tests have shown 95% cure in 15 minutes at 200°F and 100% cure in 5 minutes at 250°F, enabling high speed production applications.

Availability:

Cat. No.	Description	Temp.
Duralco 4525-1.....	Pint Kit.....	500°F
Duralco 4525-2.....	Gallon Kit.....	500°F
Duralco 4525IP-1.....	Pint Kit.....	500°F
Duralco 4525IP-2.....	Gallon Kit.....	500°F

Pre-Measured Kits

Each Unit Contains: 1 jar of resin, 1 syringe of hardener and 1 mixing stick. (See page 19 for details)

EE4525-10.....	10 Epox-Eez 10gm units/box
EE4525-25.....	10 Epox-Eez 25gm units/box
EE4525IP-10.....	10 Epox-Eez 10gm units/box
EE4525IP-25.....	10 Epox-Eez 25gm units/box

Also Available in Epox-Eez Twin Pack Cartridges

Quantity Prices & Custom Formulations

Available on Request



**4525 Bonds a 316 S.S. Shaft to a Ceramic Piston
Repairing a High Temperature Acid Pump**

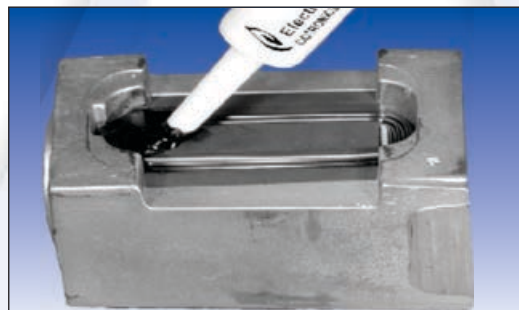

**Duralco 4525 Insulates, Seals and
Moisture-Proofs a Hi-Temp Instrument**

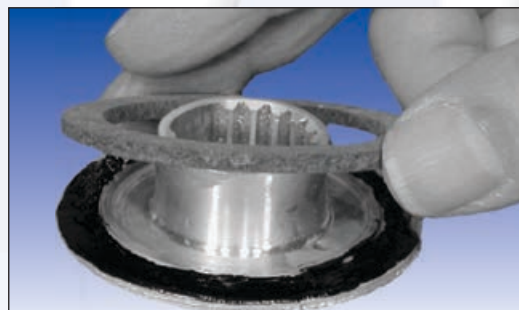

Duralco 4525 Bonds a Hi-Temp. Brake Assembly

Duralco™	4525	4525IP
Maximum Temp	500°F	500°F
Components - Color	2-Black	2-Black
Mixed Viscosity (cps)	12,400	24,000
Hardness (Shore D)	90	90
Tensile Strength (psi)	10,000	10,000
Thermal Cond. (BTU-in/Hr. Ft ² -F)	13	13
Thermal Expansion (10 ⁻⁵ /°C)	3.30	3.10
Dielectric Strength (volts/mil.)	450	425
Volume Resistivity (ohm-cm)	10 ¹⁵	10 ¹⁵
Heat Distortion (°C)	210	213
Elongation (%)	2	2
Thermal Stability (% 1000 hr @ 200°C)	0.05	0.05
Shrinkage (% max.)	0.20	0.20
Moisture Abs. (% after 30 days)	0.20	0.20
Mix Ratio (R/H)	100/8	100/8-12
Cure (Hr. @ R. T.)	16-24*	16-24*
Optimum properties post cure hrs. @ 250°F	1	1
and hrs. @ 350°F	1	1

* Cures can be accelerated with mild heat.

500°F ROOM TEMP CURING, LOW VISCOSITY EPOXY

Bonds, Coats, Seals and Protects

500°F - DURALCO™ 4461

Ultra Thin Bond Lines

Seals Porous Materials

Impregnates Fine Structures

Forms Protective Coatings

Duralco Low Viscosity Adhesives are formulated with Cotronics' unique polymer system to provide the ultimate in high temperature chemical, electrical and moisture resistance.

They are user friendly, 100% solid formulations.

No volatiles. No VOC's. No harsh odors.

Duralco 4461 is a free flowing, liquid adhesive that is ideal for forming ultra thin bond lines, impregnating, coating and encapsulating applications.

Has excellent adhesion to metals, plastics, ceramics, glass, etc.

Cures at room temperature to provide chemical, solvent and corrosion resistance in any high temp. application.

Can be used up to 500°F as a protective coating for coils, filament windings, electronics, etc.

It is an ideal choice for high temperature applications in electronics, optics, instrumentation, etc.

Users Report:

- Fiber Optic Cables consisting of 3,000 glass strands were encapsulated, and bonded, with 4461 in a 1/8" stainless steel tube. The low viscosity of 4461 enabled full penetration in and around the fiber stands.
- 4461 Bonds optical components and protects them from moisture absorption and transmission.
- 4461 Pots a transformer for high temperature service.

Availability:

Cat. No.	Description	Temp.
Duralco 4461-1.....	Pint Kit	500 °F
Duralco 4461-2.....	Gallon Kit	500 °F
Duralco 4461IP-1.....	Pint Kit	500 °F
Duralco 4461IP-2.....	Gallon Kit	500 °F

4461SS, New, Slow Setting Version

Ideal for large volume potting and casting applications.

Duralco 4461SS-1.....	Pint Trial Kit	500 °F
Duralco 4461SS-2.....	Gallon Kit	500 °F

Pre-Measured Kits

Each Unit Contains: 1 jar of resin, 1 syringe of hardener and 1 mixing stick. (See page 19 for details)

EE4461-10.....	10 Epox-Eez 10gm units/box
EE4461-25.....	10 Epox-Eez 25gm units/box
EE4461IP-10.....	10 Epox-Eez 10gm units/box
EE4461IP-25.....	10 Epox-Eez 25gm units/box



**4461 Penetrates and Encapsulates
A Semi-Conductor Device**

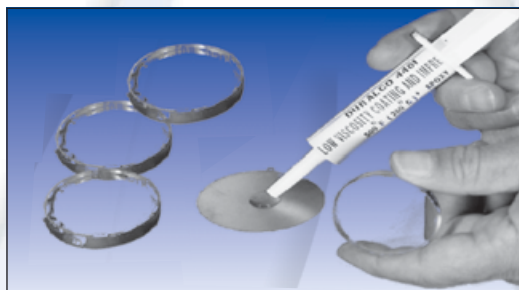

4461 Bonds an Optical Component

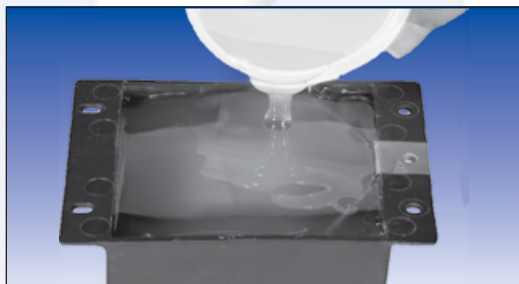

**4461 Potting a Transformer
for High Temp. Use**

Duralco™ Maximum Temp	4461 500°F
Components - Color	2-Amber
Mixed Viscosity (cps)	3,600
Hardness (Shore D)	85-95
Tensile Strength (psi)	9,500
Thermal Conductivity (BTU-in/Hr. Ft ² °F)	4
Thermal Expansion (10 ⁻⁵ /°C)	5.40
Dielectric Strength (volts/mil.)	450
Volume Resistivity (ohm-cm)	10 ¹³
Heat Distortion (°C)	210
Elongation (%)	5
Thermal Stability (% 1000 hrs @ 200°C)	0.20
Shrinkage (% max.)	0.80
Moisture Absorption (% after 30 Days)	0.15
Mix Ratio (R/H)	100/17
Cure (Hr. @ R. T.)	16-24*
(Min. @ 250°F)	5

* Cures can be accelerated with mild heat.

450°F SUPER FLEXIBLE EPOXY

So Flexible You Can Tie it in a Knot

450°F - DURALCO™ 4538

Now, unlike ever before, there is a solution for applications requiring the ultimate in thermal shock and vibration resistance, sound absorption and excellent adhesion to dissimilar substrates.

Duralco 4538 offers the flexibility of silicones and the chemical stability of epoxies.

This completely variable system can be tailored to meet any application requirement just by varying the mix ratio of resin to hardener resulting in the exact degree of flexibility required for any application.

It's easy to use. Just dispense resin and hardener, mix to a uniform color and apply.

Adheres to most plastics, metals, ceramics, glass, rubber and even Teflon™ (treated).

Cures at room temp. for use from -100°F to +450°F and will not soften or gum up at high temperatures.

Duralco 4538 offers excellent chemical resistance and high bond and peel strength.

It is ideal for all electric and electronics applications and can be used with most common chemicals and solvents.

Users Report:

Bonds: Zytel™ 101, Victrex™, Poly-Phenylsulfone, Nylon, Poly-Carbonates, Phenolics and other difficult materials. Successfully bonds a Teflon™ housing to a Ceramic Bushing, Ceramic magnets to a plastics holder.

Thermal Shock Resistance: Withstands repeated thermal cycling from -100°F to +300°F.

Seals: Bonded and sealed a 4 inch diameter glass sight port to a brass housing for use from -100°F to +300°F.

Encapsulates: Stress free potting of delicate electronic assemblies for severe thermal shock environments.

High Peel Strength: Adheres to Teflon™ (treated) and other hard to bond plastics.

Duralco 4538's convenient room temperature cure and superior high temperature performance makes it easy to use in any prototype or production application.

Adjusting the Flexibility

Just pick the degree of flexibility desired.

Then select the resin to hardener ratio from the table.

- Use formulation "A" for applications where additional rigidity is required.
- Use formulation "B" for most applications.
- Use formulation "C" or "D" for severe thermal shock, vibration or bonding of dissimilar materials that require additional flexibility.



So Flexible You Can Tie it in a Knot
Great for Stress Free Bonding & Encapsulating

Duralco™	4538
Maximum Temp	450°F
Components - Color	2-Tan
Mixed Viscosity (cps)	14,000
Hardness Variable (Shore A)	60-80A
Tensile Strength (psi)	6,000
Thermal Conductivity (BTU-in/Hr. Ft ² °F)	7
Thermal Expansion (10 ⁻⁵ /°C)	N/A
Dielectric Strength (volts/mil.)	450
Volume Resistivity (ohm-cm)	10 ¹⁴
Elongation (%)	80
Thermal Stability (% 1000 hr @ 200°C)	0.50
Shrinkage (% max.)	0.80
Moisture Absorption (30 Days %)	0.50
Mix Ratio (R / H)	100/120
Cure Hr. @ R.T.	4 - 24
@ 250°F (min.)	60

Formulation	A	B	C	D
Flexibility	Rigid	Flexible	Soft	Softest
Resin (by wt.)	100	100	100	100
Hardener (by wt.)	80	120	200	300
Physical Properties	A	B	C	D
Hardness (Shore A)	100	60	40	30
Tensile Strength (psi)	8000	6000	2500	1200
Elongation (%)	4	8	20	80

Availability:

Cat. No.	Description	Temp.
Duralco 4538-1A.....	½ Pint	450°F
Duralco 4538-1.....	Pint Kit	450°F
Duralco 4538-2.....	Gallon Kit	450°F

Pre-Measured Kits

Each Unit Contains: 1 jar of resin, 1 syringe of hardener and 1 mixing stick. (See page 19 for details) (Ration 100 Resin to 120 Hardener unless otherwise specified)

EE4538-10.....	10 Epox-Eez 10gm units/box
EE4538-25.....	10 Epox-Eez 25gm units/box

For Epox -Eez Twin Pack Cartridges see page 18.

500°F ELECTRICALLY CONDUCTIVE ADHESIVE

For High Power Applications

500°F - DURALCO™ 120

Resistance is 0.00008 ohm-cm

Just Mix and Apply

Cures at Room Temperature

Ideal for All Applications

Duralco 120 Epoxy Adhesive Forms Super Electrically Conductive Bonds for continuous use from - 50 to + 500°F.

This epoxy contains over 70% Ultra Fine, Active Silver providing the ultimate in electrical conductivity.

Resistance measurements of 0.00008 ohm-cm has been reported in many independent tests.

Duralco 120 has excellent adhesion to copper, steel, stainless, aluminum, lead, glass, ceramics, plastics and dissimilar materials.

Cures at room temperature or mild heat to offer superior resistance to moisture, most chemicals and solvents.

Duralco 120 is commonly used in place of solder for electrically conductive bonds, bonding heat sensitive components, etc.

Using Duralco 120 instead of solder avoids exposing parts to soldering temperatures, flux contamination in addition to simplifying lab or production processing of parts.

Applications Include: bonding circuits, solder replacement, bonding semi-conductors, EMI shielding, thermistors, wire tacking, heating elements, assembling electronics, etc.

Users Report:

- Duralco 120 was used for an application at 200°C for over 12 months with no degradation in electrical conductivity.
- Duralco 120 successfully bonded bus bars and carried a current of 2400 amps for a short term test.
- Duralco 120 bonds sputtering targets to copper based plates and provides 100°C continuous service.

Duralco 120 is the ideal choice for high power, high temperature, electronic or industrial application requiring high electrical conductivity.

Availability:

Cat. No.	Description	Temp.
Duralco 120-1.....	2 oz. Kit	500°F

Pre-Measured Kits

Each Unit Contains: 1 jar of resin, 1 syringe of hardener and 1 mixing stick. (See page 19 for details)

EE 120-2.....	3 - 10gm units/box
EE 120-3.....	6 - 10gm units/box
EE 120-10.....	10 - 10gm units/box

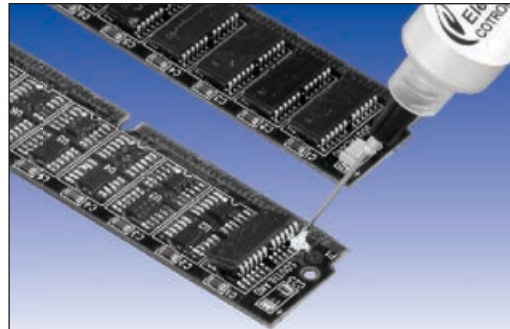

**Duralco 120 in
A Surface Mount Application**



**Duralco 120 Bonds
Leads to a Instrument Assembly**

Physical Properties

Max. Use Temp.	500°F
Volume Resistivity (ohm-cm)	0.00008
Base	Ultra Fine Silver
Color	Silver
Consistency	Smooth Paste
Components	2
Density (gms/ 0.9 cc)	3.80
Mixed Viscosity (cps at 100°F)	Smooth Fine Paste
Hardness (Shore D)	70
Die Shear strength	31.8N/mm ²
Lap Shear Strength (psi)	1500
Flexural Strength (psi)	1150
Compressive Strength (psi)	6000
Thermal Expansion (10 ⁻⁵ /°C)	4.10
Thermal Cond. (BTU-in/Hr. Ft ² °F)	50
Mix Ratio	100 to 3.4
Cure Time Hr. @ R. T.	16
Hr. @ 100°F	4
Hr. @ 150°F	2
Min. @ 200°F	10
Min. @ 250°F	7

650°F ELECTRICAL CONDUCTIVE ADHESIVES

For Electronic and Industrial Applications



Duralco 120 Replaces Soldering in an Lamp Assembly

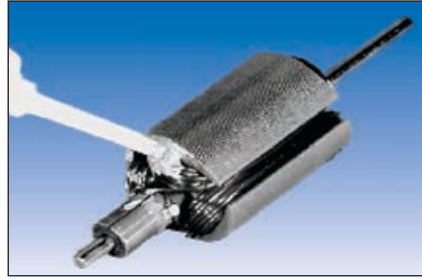

Duralco 120 Provides Conductive Paths In a High Temp. Motor



Duralco 125 Replaces Soldering on a Circuit Board

Duralco™	120	122	124	125	126	127
Major Constituent	Silver	Nickel	Silver	Silver	Silver	Graphite
Features	Hi-Conductive	Low Cost	Hi-Temp.	Flexible	One Component	Low Cost
Max. Temperature °F	500	500	650	450	450	400
Volume Resistance ohm-cm.	0.00008	0.7	0.002	0.002	0.002	0.02
Thermal Cond. (BTU-in/hr.°F Ft ²)	50	15	50	40	50	25
Mixed Viscosity cps	Smooth Fine Paste	Smooth Fine Paste	Smooth Fine Paste	Smooth Fine Paste	Smooth Fine Paste	Smooth Fine Paste
Cure Cycle Hrs. @75°F	16 - 24	16 - 24	4hr.@ 250	16-24	½ hr.@ 275	16 - 24
Cure Cycle @ 200°F	10 min.	10 min.	N.A.	20 min.	10 min @ 325	20 min.
Color	Silver	Silver	Silver	Silver	Silver	Black
No. of Components	2	2	2	2	1	2
Size ounces	2	4	2	1	2	2.5

Duralco™ Conductive adhesives and potting compounds provide the conductivity required for many high temp. electronic and industrial applications.

These Ultra Temp. Adhesives combine Cotronics' unique resins and hardeners with specialty conductive fillers to provide continuous service up to 650°F.

They will bond to glass, ceramics, metals and plastics and offer excellent resistance to most chemicals and solvents.

Applications Include: Solder replacement, semi-conductor bonding, shielding, electronics, circuit board repair, etc.

Duralco 120 500°F Silver Based

A Silver filled epoxy that cures at room temp. to form electrically conductive bond lines for use to 500°F.

Contains over 70% Ultra Fine Active Silver to provide the ultimate in electrical conductivity. Resistance of 0.00008 ohm-cm have been reported in independent tests.

Duralco 120 is ideal for forming electrically conductive bonds, attaching heat sensitive components and as a solder replacement.

Duralco 122 500°F Nickel Based

This Nickel filled adhesive and casting epoxy was specially formulated to provide an economical alternative to silver filled, electrically conductive epoxies.

Duralco 122 is low in cost and highly conductive.

It is ideal for use in applications where the upmost in electrical conductivity is not required.

Can be used to 500°F.

Duralco 124 650°F Ultra Temp Silver Based

A two component, silver filled adhesive for High Power applications

Just mix and cure with mild heat. Can be used up to 650°F.

Users report: Duralco 124 provided a conductive bond for over 6 months at 650°F.

Duralco 125 450°F Flexible Conductive Silver Based

Easy to use, "one to one", applicator kit. Just dispense, mix and apply this smooth creamy paste and cure at room temp.

Bonds to most metals, ceramics, and plastics to form stress free, electrically conductive bonds.

Duralco 126 450°F One Component, Silver Filled

A one component, highly conductive epoxy specifically designed for production applications. No mixing. no mess. Just dispense and heat cure.

Commonly used in automatic dispensing equipment.

Duralco 127 400°F Graphite Based Dispenser Kit

Easy to use, "one to one", applicator kit. Just dispense, mix and apply. This smooth creamy paste cures at room temp. and is ideal for low cost production applications. Can be used in automatic dispensing equipment.

Cat. No.	Temp	Size
Duralco 120.....	500°F	2 oz
Duralco 122.....	500°F	4 oz
Duralco 124.....	650°F	2 oz
Duralco 125.....	400°F	1 oz
Duralco 126.....	450°F	2 oz
Duralco 127.....	400°F	2 oz

500°F THERMALLY CONDUCTIVE ADHESIVE

For High Power Applications

500°F DURALCO™ 132

Just Mix and Apply

Cures at Room Temperature

Provides Fast Heat Transfer

Ideal for any Industrial, Electrical or Electronic Application

Duralco thermally conductive adhesives combine Cotronics' unique, high temperature resins with highly conductive fillers to form thermally conductive, adhesive bonds with continuous service up to 500°F.

Easy to use. Just mix and apply.

100% solids formulations. No volatiles. No VOC's.

Duralco 132 has excellent adhesion to metals, glass, ceramics, and plastics.

Offers excellent resistance to chemicals solvents and moisture.

Provides the heat dissipation required for many high temperature electronic and industrial applications.

Users Report:

- Duralco 132 dissipates heat in a semiconductor device.
- Duralco 132 transfers the heat generated in high power devices and provides for efficient cooling.
- Duralco 132 bonds electrical heating elements for fluid heating.

Applications include: bonding and assembling heating coils, cooling coils, heating elements, heat sinks, reaction vessels, semi-conductors, rectifiers, power supplies, replacement for soldering and welding, etc.

Duralco 132P is commonly used as a heat tracing adhesive which is used to bond heating or cooling tubing to equipment. Its' non sag formulation and room temperature curing, provides for the most efficient placement of the heating or cooling coils.

Duralco 132 is the ideal choice for high temperature, high power electronic or industrial applications requiring high thermal conductivity.

Availability:

Cat. No.	Description	Temp.
Duralco 132-1.....	16 oz. Kit	500°F
Duralco 132-2.....	32 oz. Kit	500°F
Duralco 132IP-1.....	16 oz. Kit	500°F
Duralco 132IP-2.....	32 oz. Kit	500°F
Duralco 132P.....	16 oz. Kit	500°F
Duralco 132P-IP.....	16 oz. Putty.....	500°F

Pre-Measured Kits

Each Unit Contains: 1 jar of resin, 1 syringe of hardener and 1 mixing stick. (See page 19 for details)

EE 132-10.....	10 - 10gm units/box
EE 132-25.....	10 - 25gm units/box
EE 132IP-10.....	10 - 10gm units/box
EE 132IP-25.....	10 - 25gm units/box

Quantity Prices & Custom Formulations
Available on Request

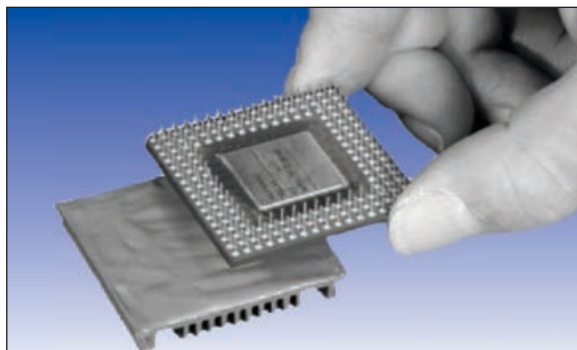

Duralco 132 Dissipates Heat in A Semi Conductor Device



Duralco 132 Bonds Electrical Heating Element for Fluid Heating

Physical Properties	132	132IP
Maximum Temp	500°F	500°F
Components - Color 2	2-Grey	2-Grey
Viscosity (cps)	15,000	43,000
Hardness (Shore D)	75	75
Flexural Strength (psi)	1,150	1,600
Compressive Strength (psi)	6,000	6,350
Thermal Conductivity (BTU-in/Hr. Ft ² °F)	40	40
Thermal Expansion (10 ⁻⁵ /°C)	4.10	4.10
Volume Resistivity (ohm-cm)	10 ⁶	10 ⁶
Heat Distortion (°C)	210	210
Thermal Stability (%1000 hr @ 200°C)	0.20	0.20
Shrinkage (% max.)	0.80	0.80
Moisture Absorption (30 Days %)	0.20	0.20
Mix Ratio (R/H)	100/8	100/8
Cure (Hrs. @ R. T.)	16-24*	16-24*

* Cures can be accelerated with mild heat.

600°F THERMALLY CONDUCTIVE ADHESIVES

For Electrical and Industrial Applications

Duralco Thermally Conductive adhesives and potting compounds provide the heat dissipation required for many High Temperature Electronic and Industrial applications.

These ultra temp. adhesives combine Cotronics' unique polymer system and special thermally conductive fillers to provide continuous service up to 650°F.

Duralco Conductive Adhesives have excellent adhesion to glass, ceramics, metals and plastics.

Resistant to most chemicals and solvents.

They are ideal for all high temperature applications.

Applications Include:

- Removing the heat generated in many electronic applications including semi-conductors, rectifiers, high power devices, etc.
- Heat transfer applications, including bonding copper coils to reaction vessels for heating and or cooling. Heat tracing adhesive. etc.
- Fabrication of heated, plastic forming tools, molds, etc.

Duralco™	128	132	133	134	135
Maximum Temp	500°F	500°F	600°F	500°F	500°F
Major Constituent Features	Ceramic Hi Electrical Resistance	Aluminum Hi Thermal Conductivity	Aluminum High Temperature	Ceramic Electrically Resistant Grease	Aluminum Thermally Conductive Grease
Volume Resistance (ohm-cm.)	10 ¹⁵	10 ⁸	10 ⁸	10 ¹⁶	N. A.
Thermal Conductivity (BTU-in/Hr. F ² -F)	20	40	40	35	40
Viscosity (cps)	79,000	15,000	36,500	Grease	Grease
Color	Tan	Silver	Silver	Tan	Gray
No. of Components	2	2	2	1	1
Mix Ratio	100/5	100/8	100/30	N. A.	N. A.
Cure Cycle (Hrs. @ 75°F)	16 - 24*	16 - 24*	4 hrs. @ 250	N. A.	N. A.

* Cures can be accelerated with mild heat.



Duralco 132 Dissipates Heat in a Semiconductor Device

Duralco 128 - 500°F Ceramic Based

Duralco 128 is highly thermally conductive, electrically resistant adhesive and potting compound.

The ceramic fillers are carefully chosen to provide high thermal conductivity and high dielectric strength.

Just mix the resin and hardener, apply and cure at room temp. Curing may be accelerated with mild heat.

Duralco 132 - 500°F Aluminum Based

Duralco 132 is an Aluminum Metal Filled Epoxy that cures at room temperature to form machinable, thermally conductive bond lines.

Duralco 132 provides the maximum heat transfer available in a 500°F epoxy system.

Can be supplied as a non-sag putty, Duralco 132P, for heat tracing applications.

Users report 132 bonds copper coils to vessels for rapid heating and cooling in a critical chemical process.

Used for bonding, assembling and heat tacking applications.

Cat. No.	Description	Temp.
Duralco 128.....	8 oz.	500°F
Duralco 132-1.....	16 oz.	500°F
Duralco 132-2.....	32 oz.	500°F
Duralco 132IP-1.....	16 oz.	500°F
Duralco 132P.....	16 oz.	500°F
Duralco 132P-IP.....	16 oz.	500°F
Duralco 133.....	16 oz.	600°F
Duralco 134.....	8 oz.	500°F
Duralco 135.....	4 oz.	500°F
Duralco 135.....	8 oz.	500°F

Quantity Prices, Special Packing on Request

Duralco 133 - 600°F Aluminum Based

Duralco 133 is a two component, heat curing, Aluminum Filled, Conductive Epoxy.

Duralco 133 combines the excellent properties of Duralco 132 with Cotronics' higher temp. epoxy systems making it suitable for applications requiring up to 600°F service.

Cures with mild heat to form thermally conductive bond lines and heat transfer medium.

Duralco 133 is suitable for high temperature tooling. It is readily machinable and ideal for all kinds of repairs and as a construction material.

Duralco 134 - 500°F Ceramic Based Grease

Duralco 134 thermally conductive grease, is a non-hardening, electrically insulating and thermally conductive grease. It is ideal for use between components and heat sinks.

Users Report Duralco 134 replaced silicone based grease in manufacturing of high end digital cameras.

Duralco 134 retains its paste like consistency, enabling parts to be easily removed and replaced. Will not dry out even after long periods of time. Usable to 500°F.

Duralco 135 - 500°F Aluminum Based Grease

Duralco 135 is filled with an ultra fine, aluminum metal powder to provide the maximum possible heat transfer rate in a non hardening grease.

Used in delicate military applications where excess heat build up can cause serious failures.

Duralco 135 is commonly used in many industrial applications where electrical resistance is not critical.

MACHINABLE CERAMICS INSTRUCTIONS

310 - 914 - 960 - 915 - 56L

MACHINING TOOLS

Use only sharp cutting tools, carbide cutting tools are preferred. Check tools for sharpness frequently. Ceramics can cause rapid wear of cutting edges. Clamp work firmly to avoid vibration and chatter.

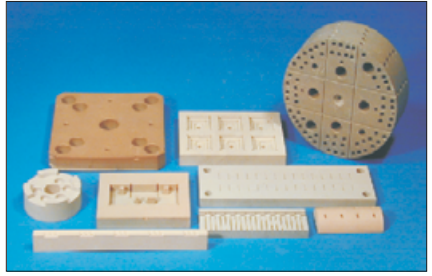

LUBRICATION

Keep a continuous stream of water on the work and tool. Insufficient lubrication will cause dulling of cutting tools and chipping of the ceramic. Lubrication is a must for precision work. Lubricants recommended include Cimstar 40 Pink, Supercut S67 and Quaker 103.

CUTTING

Use bonded silicon carbide or diamond cut off wheel with speeds of 6000 - 8000 S.F.M. (2000-2500 rpm). Cut down into work.

BANDSAW

Blade type continuous coat, carbide grit. Use a band speed of 100 feet per minute.

DRILLING

Use Carbide drills, Carboloy 883 or equivalent. For high speed drills, drill slower. Never drill all the way through. Use a drill jig and drill from both sides. Re-sharpen bits every 3 - 4 holes.

Drill Size	RPM	Feed - RPI	Drill Size	RPM	Feed - RPI
1/4 inch	300	0.005	3/4 inch	200	0.010
1/2 inch	250	0.007	1 inch	100	0.012

MILLING

Cutting Speed (surface ft. per min.).....20 - 35
Chip Load (inches per tooth).....0.002
Depth of Cut (inches).....0.150 - 0.200

THREADING

Use a diamond wheel with a tool post grinder or tungsten carbide tools.

TAPPING

Use high speed steel or carbide. Drill size should allow for 70% thread form. Use lubricant.

TURNING

Use carbide tool bits or silicon carbide wheels on post grinder.
Tool Type.....Carboloy 883
Cutting Speed (surface ft. per min.).....30 - 50
Feed Rate (inches per revolution).....0.002- 0.005
Depth of Cut (inches).....0.150- 0.250

GRINDING

Use a silicon carbide, resinoid bonded wheel at the recommended speeds. Use a soft, coarse grained wheel for heavy grinding. Use a hard, fine grained wheel for finishing. No heat treating is required, however, shrinkage may occur in use. A test piece should be exposed to the service temp. (for the usage time) to check for shrinkage before committing to making actual parts.

NOTE: Cotronics ceramics particles are abrasive clean machines thoroughly after machining.

SPECIALTY HIGH TEMP. ADHESIVES

Magnet Bonding - Quick Set Superbonder - Thermal Bonder

500°F - DURALCO™ Nm25

Magnet Bonding Adhesive

Duralco NM25 is an adhesive proven for bonding magnets while withstanding the high temperatures encountered in high performance applications.

It is free of magnetic particles or conductive fillers which would interfere with magnetic fields when in use. Just mix and apply. NM25 cures at room temperature to provide excellent chemical solvent and moisture resistance.

Will form thin bond lines and is ideal for use in applications with minimum clearance.

NM25 has a medium viscosity and can form thin bond lines. NM25 HV is a non-sag, putty.

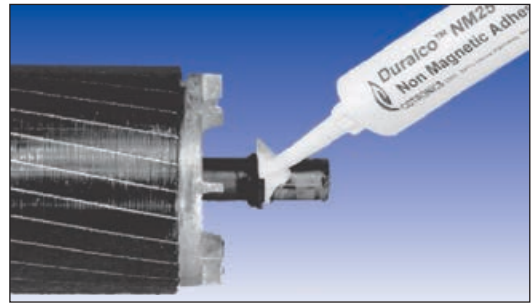

Duralco NM25 Bonds a Motor Shaft Providing a High Strength Bond without Magnetic Interference

450°F - BOND-IT™ 007

“Quick Set Superbonder”

No measuring. No mess. Just mix equal parts of resin and hardener and apply.

Hardening starts in just 5 minutes. Bond strengths measuring 3,000 psi are reached in just a few hours.

Bond-IT 007 has excellent adhesion to most metals, ceramics, glass, plastics, composites, etc.

Users Report:

- Bond-IT 007 repairs a heater assembly in a chemical plant, eliminating any downtime. The assembly operated successfully at 300°F.

Applications include bonding ceramics to metals, brake pads to metals, assembling and repairing machines, etc.

Bond-IT 007 is the best adhesive for attaching thermocouples, strain gages, instruments and other difficult assemblies.

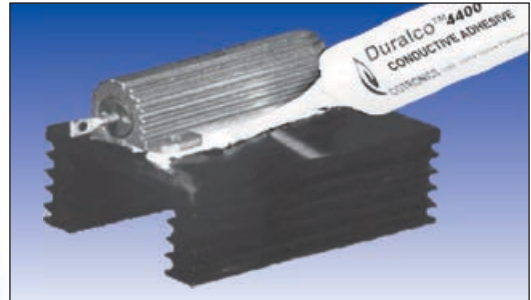

Duralco 4400 Dissipates Heat in a Semi Conductor Device



Bond-IT 007 Bonds a sensor to a High Temp. Heating Element

500°F - DURALCO™ 4400

Transmits Heat - Electrically Resistant

Use Duralco 4400 for high strength, thermally conductive and electrically resistant bonds. Cures at room temperature without any objectionable odors.

Duralco 4400 provides the thermal shock resistance and flexibility required to accommodate differences in thermal expansion which occurs during high heat flows.

Users Report:

- A “glass feed thru” was bonded to a brass housing and repeatedly cycled from liquid Nitrogen temperatures to 250°F, while maintaining its vacuum integrity.

Duralco 4400’s unique combination of bond strength and thermal conductivity proved to be successful in this severe environment.

Cat. No.	Description	Temp.
Duralco NM 25-1.....	Pint Kit	500°F
Duralco NM 25 HV-1.....	Pint Kit	500°F
Duralco NM 25 HT-1.....	Pint Kit	500°F
Duralco 4400-1.....	Pint Kit	500°F
Duralco 4400-2.....	Gallon Kit	500°F
Bond-IT 007.....	Applicator Kit	400°F

For Epox-EEZ Pre-Measured Epoxy Kits see page 19.

Quantity Prices or Custom Formulations on Request

Duralco™	NM25	NM25HT	4400	007
Maximum Temp.	500°F	600°F	500°F	450°F
Components - Color	2-Tan	2-Tan	2-Tan	2-Tan
Viscosity (cps)	20,000	20,000	83,000	100,000
Density (gm/cc)	1.90	1.90	2.10	1.32
Hardness (Shore D)	80	94	80	70
Tensile Strength (psi)	10,000	11,100	7,000	3,000
Thermal Cond. (BTU-in/Hr. Ft ² F)	13	13	20	7
Thermal Expansion (x 10 ⁻⁵ /°C)	3.30	3.70	3.50	4.80
Dielectric Strength (volts/mil)	500	555	625	450
Volume Resistivity (ohm-cm)	10 ¹⁵	10 ¹⁶	10 ¹⁴	10 ¹³
Heat Distortion (°C)	210	300	170	150
Elongation (%)	2	2	2	3
Thermal Stability				
(1000 hr. @ 200°F)	0.50	0.10	0.60	0.50
Shrinkage (% max.)	0.20	0.20	0.40	1.00
Moisture Absorption				
(% 30 days @ 50°C)	0.20	0.20	0.28	0.80
Cure (Hrs. @ Room Temp.)	4-16*	4 @ 250°F	4-16*	4-16*

* Cures can be accelerated with mild heat.

SPECIALTY HIGH TEMP. ADHESIVES

Nylon Bonder - Sterilizable - Low Expansion

400°F - BOND-IT™ 7050

Super Nylon Bonder

Bond-IT 7050 is an activated epoxy that incorporates adhesion promoters right into the epoxy's backbone structure permanently improving the epoxy's adhesion and bond strength.

Adheres to most plastic surfaces producing bonds that are in many cases, stronger than the plastic substrates themselves.

Bonds combinations of dissimilar materials including metals, ceramics, plastics, glass, etc, and cures at room temperature.

Users Report:

- 7050 bonds nylon to aluminum housings with the bond strength required for a high performance lighting fixture.

Bond-IT is packaged in easy to use dispenser kits making it ideal to have in any shop, lab or production facility.

Cat. No.	Description	Price
Bond-IT 7050-1.....	Dispenser Kit	34.13
Bond-IT 7050-2.....	Pint Kit	99.70

500°F - RESBOND™ S5H13

Hot Sterilizable

Resbond S5H13 is a unique epoxy that after a simple room temperature cure can assemble, bond and insulate stainless steel, metals, glass and ceramic components for use up to 500°F.

Specially formulated to resist the severe conditions that are encountered during repeated hot sterilization as required for various medical applications. It is resistant to most common chemicals and solvents.

Users Report:

- Resbond S5H13 seals Bi-Polar, Electro- Cauterizers and withstands thousands of successful sterilization cycles at 375°F.

S5H13 is commonly used for high performance bonding, assembling, potting, sealing, coatings and repairs in instruments, devices, equipment, etc..

Cat. No.	Description
Resbond S5H13.....	Pint Kit
Resbond S5H13.....	Gallon Kit

500°F - DURALCO™ 4463

Low Expansion Adhesive & Potting

Duralco 4463 is a low expansion, 500°F, room temperature curing adhesive and potting compound

Bonds to most glass, ceramics, metals, plastics, etc.

Use this unique system for high performance bonding and encapsulation applications.

Low expansion is a must in many electronic, optical and fiberoptic applications. 4463 offers strength, high temperature stability, thermal shock resistance, chemical resistance and low shrinkage.

Cat. No.	Description
Duralco 4463-1.....	½ Pint Kit
Duralco 4463-2.....	Pint Kit

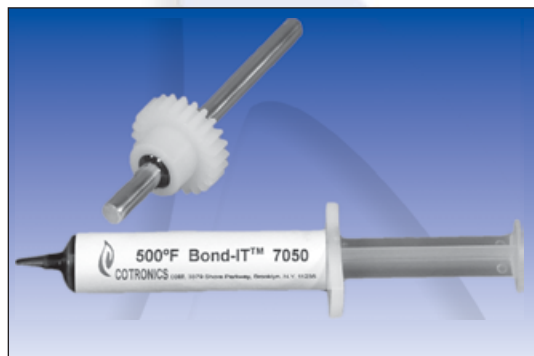

Bond-IT 7050 Bonds Quartz Lamp into a Plastic Holder

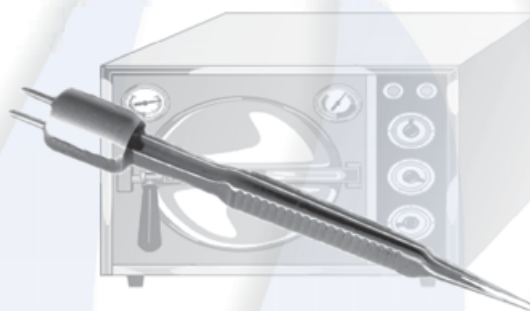

Resbond S5H13 Seals Bi-Polar Electro-Cauterizers

Duralco™	7050	S5H13	4463
Maximum Temp	450°F	500°F	500°F
Components - Color	2-Black	2-Black	2-Gray
Mixed Viscosity (cps)	10,000	12,000	176,000
Density (gm/cc)	1.30	1.80/ 0.90	1.50
Hardness (Shore D)	70	85	75
Tensile Strength (psi)	5,000	10,000	7000
Thermal Cond (BTU-in/Hr. Ft ² °F)	4.50	13	5.00
Thermal Expansion (x 10 ⁻⁵ /°C)	4.80	3.30	2.00
Dielectric Strength (volts/mil.)	400	500	600
Volume Resistivity (ohm-cm)	10 ¹⁴	10 ¹⁵	10 ¹⁴
Heat Distortion (°C)	75	210	210
Elongation (%)	3	2	2
Thermal Stability (% 1000 hr. @ 200°C)	0.50	0.50	0.50
Shrinkage (% max)	0.80	0.20	0.50
Moisture Absorption (% 30 Days)	0.20	0.20	0.30
Mix Ratio (R/H)	100/10	100/13	100/6
Cure (Hr. @ Room Temp.)	4-16*	16-24*	4 -16*
Cure (Hr. @ High Temp.)	1-2 hrs. @ 200°F	1-2 hrs. @ 250°F	1-2 hrs. @ 250°F

* Cures can be accelerated with mild heat.

For Epox-EEZ Pre-Measured Kits See Page 19

SINGLE COMPONENT ADHESIVES

No Mixing, Measuring or Mess, Just Apply and Heat Cure

450°F - DURALCO™ 4420

Electrically Resistant Adhesive

Duralco 4420 is ceramic filled and offers excellent electrical properties. No measuring, mixing or mess. Just apply and heat cure. (See table for cure cycles.)

Adheres to ceramics, glass, metals, plastics, mica, bond dissimilar materials, etc. and has excellent resistance to solvents, fuels, lubricants and most common chemicals.

Provides the low moisture absorption required for many electronic applications.

Users Report:

- Used for high speed production applications in the electrical, electronics and appliance industries.

Cat. No.	Description
Duralco 4420-3.....	3-4 oz. Dispenser Tubes
Duralco 4420-4.....	11 oz. Caulking Tubes

450°F - DURABOND™ 455

Thermally Conductive Structural Adhesive

Durabond 445 is a one component, 100% solids, all purpose structural adhesive.

Filled with ultra fine, active Aluminum, Durabond 455 has the strength required for the most demanding applications.

Packaged in easy to use, 11 oz. dispenser tubes. Just apply and cure. (See table for cure cycles.)

Bonds to most metals, plastics, high performance composites, glass, ceramics, dissimilar materials, etc.

Use this unique system for high bond strength, high temp. stability, thermal shock resistance, chemical resistance, low shrinkage and machinability.

Applications include high performance bonding and assembling in appliances, aerospace, automotive, sports equipment, bonding dissimilar materials and eliminating brazing.

Cat. No.	Description
Duralco 455-1.....	11 oz. Dispenser Tube

450°F - DURALCO™ 126

Electrically Conductive Structural Adhesive

Duralco 126 Conductive Adhesive has the conductivity required for many high temperature electronic and industrial applications.

This ultra temp., one component adhesive combines Cotronics' unique resins and hardeners with specialty conductive fillers to provide continuous service up to 450°F.

Duralco 126 will bond to glass, ceramics, metals and plastics and offer excellent resistance to most chemicals and solvents.

Specially designed for production applications and ideal for use in automatic dispensing equipment.

Applications include solder replacement, semi-conductor bonding, shielding, electronics, circuit board repair, etc.

Cat. No.	Description
Duralco 126.....	2.oz. Jar



Single Component Adhesive in Ready to Use 4 oz. and 11 oz. Caulking Tubes

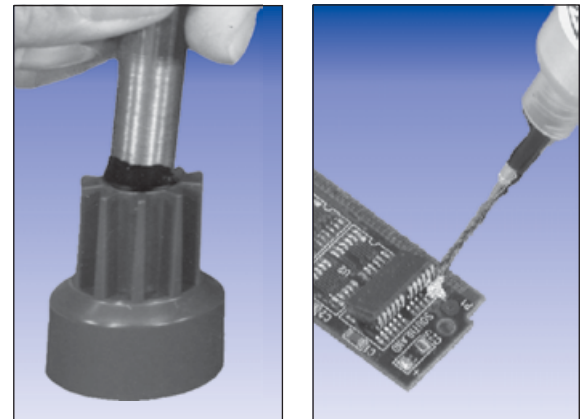

Assembling a Dip Stick and a Circuit Board

PRODUCT	455	4420	126
Maximum Temp	450°F	450°F	450°F
Density (gm/cc)	1.65	1.20	1.05
Hardness (Shore D)	80	75	75
Tensile Strength (psi)	10,000	7,000	10,000
Thermal Cond. (BTU-in/Hr. Ft ² °F)	12	8	50
Thermal Expansion (10 ⁻⁵ /°C)	6.40	4.50	6.40
Dielectric Strength (volts/mil)	400	400	500
Volume Resistivity (ohm-cm)	10 ¹⁰	10 ¹⁰	0.002
Heat Distortion (°C)	180	175	165
Viscosity (cps)	Paste	Paste	Smooth Fine Paste
Dissipation Factor (@100kc)	N/A	0.010	N/A
Dielectric Constant (@100kc)	N/A	3.80	N/A
Elongation %	1.00	1.50	1.40
Thermal Stability % (1000 hr. @ 200 °C)	0.80	0.60	0.80
Shrinkage (% max.)	0.20	0.30	0.50
Moisture Absorption % (30 days @ 50 °C)	0.40	0.50	0.50
Components (Color)	1-Grey	1-Grey	1-Silver
Cure (min @ 250°F)	30-60	30-60	30-60
(min @ 300°F)	5-30	5-30	15
(min @ 350°F)	3-15	3-15	10

SPECIAL PURPOSE EPOXIES

For Unique Applications

450°F - BOND-IT™ 7056AL

Machinable Instant Metal

Bond-IT 7056AL is a unique, super fast, machinable, repair epoxy. It does not have the odors of a 5 minute repair epoxy and will not give you sticky fingers like cyanoacrylates.

This super fast epoxy makes repairs a breeze.

No weighing, mixing or mess. Will not run, drip or sag when applied. Just dispense from a hand held, side by side dispenser tube. 7056AL cures in 4-8 minutes, at room temp., without any objectionable or sulphur odors.

BOND-IT has excellent adhesion to smooth, rough or porous surfaces, most plastics, metals, ceramics, glass wood and cures to form a hard, durable, machinable epoxy that can be machined, tapped or drilled.

Applications include repairs, rebuilds and assembles parts, components; rebuilds surfaces and even fills gaps or voids.

Cat. No.	Description
Bond-IT 7056AL-1.....	2 oz. Applicator Kit
Bond-IT 7056AL-2.....	8 oz. Kit

500°F - DURALCO™ 4540

Liquid Metal

Duralco 4540 is filled with ultra fine, aluminum metal powder creating a pourable liquid that easily penetrates fine openings, fills gaps and voids, seals, patches and repairs.

Just mix, apply and cure at room temperature for outstanding adhesion, ductility, thermal conductivity and shock resistance.

4540 is machinable and rugged. It is resistant to chemicals and solvents and can be used to 500°F.

Users Report:

- 4540 was used to cast integrally heated molds for injection molding of plastic parts
- 4540 formed highly detailed parts with high thermal conductivity, durability and wear resistance.

Applications include repairing leaks, solder joints, cracks, holes, castings, heating elements, cooling coils, instruments, etc.

Cat. No.	Description
Duralco 4540-1.....	Pint Kit
Duralco 4540-2.....	Gallon Kit

500°F - DURALCO™ T507

Teflon Paint

Duralco T507 Teflon paint cures to form a non-stick layer of Teflon that is usable up to 500°F.

It was primarily designed to create non-stick surfaces with exceptional durability due to its composite structure.

Just mix the resin with its hardener and apply. Duralco T507 cures at room temperature and can be used up to 500°F.

Duralco T507 has excellent resistance to high humidity and saline atmospheres, fuel gas exhaust, corrosive environments, organic solvents and galvanic protection.

It is commonly used on powder shutes, assembly lines, heat release films, reusable mold release, factory equipment, etc.

Ideal for processing equipment, OEM applications, etc.

Cat. No.	Description
Duralco T507-1.....	Pint Kit
Duralco T507-2.....	Quart Kit



Bond-IT 7056AL Fills a Casting Before Re-Machining



Duralco 4540 Bonds Heater Element to an Aluminum Tray

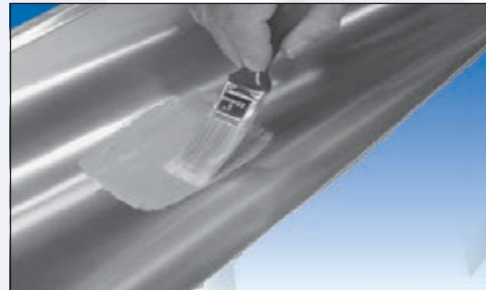

Duralco T507 Teflon Coats a High Temp. Feeder Trough

PRODUCT	7056AL	4540	T507
Maximum Temp	450°F	500°F	500°F
Density (gm/cc)	1.50	1.52	1.40
Mixed Viscosity (cps)	11,000	20,000	10,000
Hardness (Shore D)	65	80	68
Tensile Strength (psi)	10,000	10,000	5,000
Thermal Conductivity (BTU-in/Hr. Ft ² °F)	20	35	10
Thermal Expansion (10 ⁻⁵ /°C)	3.40	4.10	4.20
Dielectric Strength (volts/mil)	100	100	400
Volume Resistivity (ohm-cm)	10 ⁸	10 ⁸	10 ¹⁴
Elongation %	3.00	1.20	3.00
Thermal Stability % (1000 hr. @ 200 °C)	0.30	0.50	0.50
Shrinkage (% max.)	0.30	0.10	0.50
Moisture Absorption % (30 days @ 50 °C)	0.50	0.20	0.20
Components - Color	2-Silver	2-Silver	2-Tan
Mix Ratio (R/H)	N/A	100/9	100/15
Cure @ R.T.	4-8 min.	4-16 hrs.	4-16 hrs.
Cure @ 250°F		8 min.	30 min.

EPOX - EEZ™ HIGH PERFORMANCE TWIN PACKS

Odor Free - Room Temp. Curing Adhesives and Molding Compounds

Just Squeeze To Apply

Instant Mixing & Dispensing System

Convenient - Economical - Foolproof

Now, Cotronics' High Performance, High Temperature Epoxies are available in easy to use *Epoxy-Eez* "Twin Pack Cartridges".

Just place the twin pack cartridge into the convenient, applicator gun, snap on a mixer tube and squeeze to apply.

The completely measured and fully mixed adhesive will cure at room temperature to provide up to 500°F service.

No more time consuming weighing and measuring.

Ideal for use in any high temperature application.



Applicator Gun With Disposable Cartridges and Mixer Sticks

Epoxy-EEZ™	All Purpose 4525N	Low Viscosity 4461N	Fast Set 4537N	Easy to Machine 4540N
Maximum Temp.	500°F	500°F	450°F	500°F
Hardness (Shore D)	80	75	60	80
Viscosity (cps)	25,000	5,000	12,000	20,000
Tensile Strength (psi)	10,000	9,500	6,000	10,000
Thermal Cond. (BTU-in/Hr. Ft ² °F)	13	4	7	30
Dielectric Strength (volts/mil)	450	450	450	250
Volume Resistivity (ohm-cm)	10 ¹⁵	10 ¹³	10 ¹¹	10 ⁸
Shrinkage (% max.)	0.2	1	0.2	0.1
Elongation (%)	2	5	2	1.2
Moisture Absorption (% 30 days @ 50°C)	0.05	0.15	0.2	0.2
Thermal Stability (1000 hr. @ 200°F)	0.05	0.2	0.6	0.5
Components - Color	Black	Amber	Blue	Grey
Cure (Hr. @ RoomTemp.)	16	16	1-4	16
(Mins. @ 250 °F)	5	5	3	8



Adhesive Being Applied to Seal a Flange Joint

Availability:

Cat. No.

ETSK	Starter Pack with Reusable Applicator Gun · Contains: 1 Cartridge each of 4535N, 4461N, 4537N and 4540N
ETR	Epoxy-Eez Twin Packs Refills Package of 4- 2 oz. Cartridges · Available in 4461N, 4525N, 4535N, 4537N, 4538N and 4540N. · Specify Grade Desired. See product page for detailed data.
ETAG	Applicator Gun and Plunger
ETMT	Epoxy-Eez Disposable Mixer Tubes · Package of 10

Dispenser kits are available for most of Cotronics' systems upon request

EPOX-EEZ™ PREMEASURED KITS

Economical - Just Mix and Apply

Fool Proof

Job Sized Kits

Saves Time & Money

Just Dispense, Mix & Apply

Cotronics' High Temp., Epoxy formulations are packaged in convenient, easy to use, pre-measured kits.

No more measuring. No mess. No waste.

EPOX-EEZ Resins are pre-measured and supplied in specially designed rigid mixing cups.

EPOX-EEZ Hardeners are supplied in pre-measured disposable syringes.

Just inject one syringe of hardener into one jar of resin, mix, use and discard.

Consistent results are always obtained.

Users Report:

- EE 4525 bonds instruments, thermocouples, strain gages in many Hi-Temp. production applications.
- EE 4461 simplified the field assembly of optical fiber cables preventing moisture from decaying delicate fiber optical bundles.
- This unique EPOX-EEZ packaging resulted in 0% epoxy failure rate. The pre-measured kits eliminated problems associated with measuring and mixing.
- Technicians have found that the unique EPOX-EEZ pre-measured packaging resulted in 100% reliable bonds with full performance even in the field.

Job Sized EPOX-EEZ Pre-Measured Kits are the most economical, easy to use, foolproof epoxy system available.

They are the ideal choice for production bonding, potting and sealing. Commonly used for handy, on the job repairs and field assemblies, etc.

Packaging:

Each Box Contains 10 Units.

(10 gm units are 1/3 fl. oz., 25 gm. units are 1 fl. oz.)

Each Unit Contains

1 jar of resin, 1 syringe of hardener and mixing stick.

Pricing:

For Duralco System Numbers

128, 132, 861, 865, 4461, 4525, 4538, 4540, 4703, S5H13

• Box of 10 - 10 gm units

• Box of 10 - 25 gm units

For Duralco System Numbers

132IP, 133, 861IP, 865IP, 4400, 4460, 4461IP, 4525IP

• Box of 10 - 10 gm units

• Box of 10 - 25 gm units



Packaged in Boxes of 10 Units

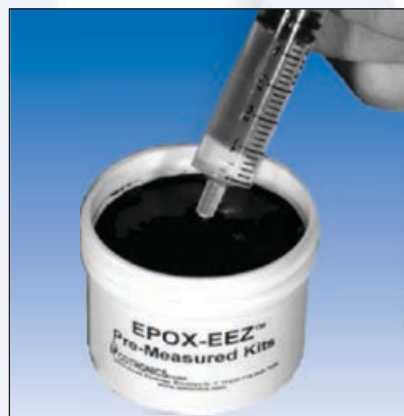

**Dispensing Hardener Into Resin
Prior to Mixing**



Mixing Epoxy Before Dispensing

DURAPOT™ EPOXIES

High Performance Casting, Embedding and Encapsulating Compounds

Durapot™	861	862	863	864	865	866	868
Max Temp.	500°F	600°F	600°F	450°F	500°F	500°F	500°F
FEATURES	Low Visc. Impregnant R.T. Cure	Low Visc. High Temp.	Ultra High Temp.	Flexible Thermal Shock	High Thermal Shock	Thermal Insulating Machinable	Hi-Temp Flexible Low Visc.
Volume Resistivity (ohm-cm)	10 ¹³	10 ¹⁴	10 ¹⁴	10 ¹⁴	10 ¹⁵	10 ¹⁵	10 ¹⁴
Dielectric Strength (volts / mil)	450	500	550	450	700	500	500
Dielectric Constant	4.15	4.15	3.5	3.5	3.5	3.5	4.1
Dissipation Factor	0.015	0.015	0.010	0.010	0.010	0.015	0.015
Thermal Exp. (10 ⁻⁵ / °C)	5.2	5.4	3.4	N/A	3.8	4.5	5.2
Therm. Cond. (BTU in/hr.F*ft ²)	4	4	9	7	20	1.5	4.0
Hardness (Shore)	80-D	80-D	90-D	60-80A	95D	60-D	60-80A
Chemical Resistivity	Excellent	Excellent	Excellent	Good	Excellent	Excellent	Excellent
Solvent Resistance	Excellent	Excellent	Excellent	Good	Excellent	Excellent	Excellent
Viscosity, Mixed (cps)	3,600	1,600	2,000	17,200	30,000	10,000	800
Pot Life (Hrs.)	30 mins.	4	8	1	1	1	2-4
Color	Amber	Amber	Amber	Tan	Grey	Tan	Amber
Components	2	2	2	2	2	2	2
Mix Ratio by Wt.	100/17	100/80	100/71	100/120	100/5	100/12	100/40
Standard Cure Temp. °F Time (Hrs.)	R. T. 16-24	250 4	250 4	R. T. 24	77 16-24	R. T. 24	250 2-4
Accelerated Cure Cycle Time @ Temp °F (25 gms)	5 mins. @ 250	60 mins. @ 350	1-2 hrs. @ 350	1-2 hrs. @ 250	10 mins. @ 250	10 mins. @ 250	60 mins. @ 350

Pre-Measured Kits

Epoxy-Eez™ in 10 gm. and 25 gm. Units (Page 19)

Post cures @ 250°F will improve moisture resistance for 861, 864, 865, 866.

DURAPOT™ EPOXIES

High Performance Casting, Embedding and Encapsulating Compounds For Electronic Applications

Durapot 861 Low Viscosity Impregnant

A 100% reactive compound for use to 500°F. 861's low viscosity will provide excellent penetration even into tightly wound coils.

Just mix and cure at room temp. and has excellent electrical, moisture and chemical resistance. Available in flame retardant grades.

Durapot 862 High Temp. Low Viscosity

A 100% reactive compound for use to 600°F. 862's low viscosity provides excellent penetration.

Usable to temperatures in the 600°F range. 862 cures at 250°F and has excellent electrical, moisture and chemical resistance.

Durapot 863 Ultra High Temp Potting

Durapot 863 is based on Cotronics' unique, Cross-Linked, Inorganic-Organic Polymer, System. Offers excellent dielectric properties, heat stability, moisture and solvent resistance.

Usable to temperatures in the 600°F range after curing at 250°F.

Durapot 864 Flexible, Cures at Room Temp.

Provides the flexibility required for severe thermal shock applications. Will bond to dissimilar materials, treated TEFLON™ and other difficult to bond plastics and offers up to 450°F continuous service.

Users Report the ability to impregnate and bond thousands of small diameter, fiber optical strands for use at 500°F.

Ideal for stress free embedding, impregnating and encapsulation. Available in flame retardant grades.

Durapot 865 High Thermal Conductivity

For applications requiring high heat flows and rapid thermal dissipation. Just mix, apply and cure at room temp. Usable to 500°F. Used for thermally conductive, casting, embedding, impregnating and encapsulation.

Durapot 866 Thermally Insulating

A 500°F epoxy based, thermally and electrically insulating compound. Convenient two part, room temperature curing system. Forms a low density, non porous foam for high temperature applications that require these unusual combinations of properties. Available in flame retardant grades.

Durapot 868 Hi-Temperature Flexible

Now, a high temp. flexible epoxy ideal for thermal shock applications, stress free potting and bonding.

Durapot 868 offers high electrical resistance, even at high temperatures, and can be used up to 500°F.



Durapot 864 is Used to Pot an Electronic Assembly to Prevent Vibration Damage

Cat. No.	Description	Kit Size Options	
Durapot 861.....	500°F Low Viscosity.....	Gallon Kits	Pint Kits 10 - 10 gm units 10 - 25 gm units
Durapot 861IP.....	500°F Low Viscosity.....	Gallon Kits	Pint Kits 10 - 10 gm units 10 - 25 gm units
Durapot 862.....	600°F Low Viscosity.....	Gallon Kits	Pint Kits 10 - 10 gm units 10 - 25 gm units
Durapot 863.....	650°F Low Viscosity.....	Gallon Kits	Pint Kits 10 - 10 gm units 10 - 25 gm units
Durapot 864.....	450°F Flexible, Shock Resistant.....	Gallon Kits	Pint Kits 10 - 10 gm units 10 - 25 gm units
Durapot 865.....	500°F Thermally Conductive.....	Gallon Kits	Pint Kits 10 - 10 gm units 10 - 25 gm units
Durapot 865IP.....	500°F Thermally Conductive.....	Gallon Kits	Pint Kits 10 - 10 gm units 10 - 25 gm units
Durapot 866.....	500°F Thermally Insulating.....	Gallon Kits	Pint Kits 10 - 10 gm units 10 - 25 gm units
Durapot 868.....	500°F High Temp. Shock Resist.....	Gallon Kits	Pint Kits 10 - 10 gm units 10 - 25 gm units

All Durapot materials can be supplied convenient job sited, pre-measured kits (see page 19) and in bulk.

New, slow set hardeners formulated to make large castings and parts are available upon request.

[Quantity Pricing is Available Upon Request](#)

DURALCO™ 865 IP

500°F Thermally Conductive Potting Compound

Ideal for Conductive Casting and Embedding

Easy To Use

Duralco 865 IP high temp., thermally conductive, encapsulant offers high dielectric strength, thermal shock resistance and chemical resistance.

Duralco 865 IP is a 100% reactive compound. No volatiles. No solvents. No outgassing.

Just mix and pour to flow into fine details.

Duralco 865 IP has excellent adhesion to metals, plastics, ceramics, glass and will cure at room temperature* with out complicated two or three stage curing cycles.

It is the ideal choice for use in critical potting / encapsulating applications requiring high thermal conductivity and electrical resistance.

*Optimum properties will be obtained with a 1 hour postcure at 250°F and an additional 1 hour at 350°F.

Maximum Temp	500°F
Density (gm/cc)	1.9-2.2
Viscosity (cps)	75,000
Hardness (Shore D)	90
Thermal Cond. (BTU-in/°F hr. Ft ²)	20
Heat Distortion (°C)	218
Thermal Stability (@ 200°C)	0.4
Shrinkage (% max.)	0.8
Moisture Absorption (%)	0.11
Cure (Hr. @ 77°F)	16-24
Components - Color	2 - Grey
Mix Ratio (R / H)	100/5

Availability:

Duralco 865 IP-1 Pint Trial Kits

Duralco 865 IP-2 Gallon Kits

Duralco 865 IP -3 5 Gallon Kits

Call for Sizes and Prices of

Ready to use Pre-Measured Kits

The information supplied is not to be taken as a warranty or representation for which Cotronics Corp assumes legal responsibility. It is offered solely for your consideration, investigation and verification. All risk of use, singly or in combination with other products, whether or not in accordance with the instructions, directions or suggestions is borne by the user.



COTRONICS CORPORATION

www.cotronics.com 131 47th Street, Brooklyn, New York 11232 (718) 788-5533 Fax (718) 788- 5538

EPOXY AIDS

Adhesion Promoters - Solvents - Thinners - Mold Release

- Improves adhesion
- Adds flexibility
- For epoxies



105RF Epoxy Flexibilizer

RESBOND FLEXIBILIZER and ADHESION PROMOTER

105RF Improves the bond strength, thermal shock resistance, and impact strength of cured epoxies.

105RF may be added to any of Cotronics' epoxies or epoxy based potting compounds to increase the adhesion of the cured system.

Add up to 30% by weight to the pre-mixed resin and hardener.

Note: the use of a high concentration of flexibilizer may reduce the maximum temperature capacity of the epoxy system.

- Lowers viscosity
- Improves flow
- For fine details



105RT Thins Epoxies

RESBOND THINNERS

105RT Resbond thinners reduce the viscosity and improve the flow characteristics that are required for special applications.

These reactive, low viscosity liquids may be added directly to Cotronics' epoxy based adhesives and potting compounds in amounts that vary from 3% to 20% by weight.

Note: A reduction in the maximum temp. capability of the epoxy system is to be expected with large additions of Resbond Thinners.

- Safe
- Easy to use
- Cleans uncured epoxies etc.



105RS Safety Solvent

RESBOND SOLVENT

105RS Solvent makes clean up for uncured epoxies, resins and hardeners quick and safe.

A high purity cleaner for a wide range of stubborn contaminants.

Resbond moderately fast drying allows a "soak time" to dissolve release agent, ejector pin greases and oily contaminants

No harsh odors. Does not contain aromatics, chlorinated solvents, caustics, etc. Will not irritate users.

Convenient spray can.

- Safe
- Easy to use
- Improves adhesion



105RP Prepares Surfaces

RESBOND SURFACE PREP

105RP Resbond Surface preparation and cleaner safely removes greases, oils, etc. with a completely bio-degradable and environmentally safe solvent.

Special additives act as adhesion promoters to prepare the surface for improved bond strength.

It is ideal for bonding applications with difficult to clean surfaces.

- Easy to use
- Just fill
- Dispense as needed



108 Dispensers

SYRINGES, CAULKING TUBES and MIXERS

Accurately dispenses into hard to reach areas.

Select from syringes, caulking cartridges or dropper bottles.

Makes quick work out of difficult and messy jobs.

Use for all of your dispensing applications.

Just fill, use and discard.

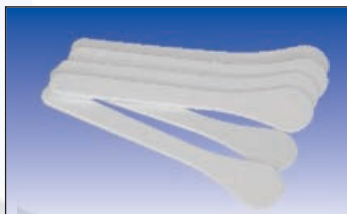

Cat. No.	Size
105RF-1.....	Pint
105RT-1.....	Pint
105RS-1.....	12 oz. Spray Can
105RP-1.....	Quart
108D-15C.....	15 cc Syringes
108D-30C.....	30 cc Syringes
108D-60C.....	60 cc Syringes
108D-11 oz.....	11 oz. Caulking
108M-1.....	6" Plastic Mixers

500°F-800°F DURASEAL™ + SILICONES

Odor Free Room Temp. Curing Adhesives and Molding Compounds

Duraseal Non-Sag Putties

- One component formulations.
- No mixing, measuring or mess.
- No harsh or acidic odors.
- Bonds to metals, glass, ceramics, plastics, etc.
- No special activators or primers.
- Will not corrode metal surfaces.
- Resistant to electricity, most chemicals and solvents.
- Safe for the most delicate electronic components.

Duraseal 1531 - Continuous use to 650°F

- Seals pipes, flanges, stacks and high temp. equipment.
- No special surface pre-treatments are necessary.
- Adheres to most metals, glass, ceramics, plastics, etc.
- Fills in voids, forms flexible gaskets and repairs.
- Provides a long lasting flexible seal, use from - 80°F to 650°F.
- Applications include: high temperature sealing, gasket forming, vibration isolation, etc.

Users Report:

- Cotronics' designed custom packages of Duraseal 1531 to be used with field installation kits. The specially sized tubes saved suppliers time and money while providing their customers a simple method to assemble parts.

Duraseal 1532 - Continuous use to 500°F

- A clear thin putty with excellent spreading ability.
- Excellent electrical insulation properties allow for a host of applications in cables splicing, electrical isolation, repair, potting, etc.
- Ideal for use as high temperature adhesive, electronic, waterproofing, sealing, impregnating, coating or vibration dampening application.

Users Report:

- Duraseal+ 1532 provides high dielectric insulation and moisture proofs cable splices in field assembly joints.
- A thin, clear layer of Duraseal 1532 moisture-proofs porous ceramics, improving the electrical resistance and providing use up to 500°F.

Duraseal 1533 - 5 Minute Casting Compound

New, unique Duraseal 1533 flows into the finest cracks and crevices to form stress free bonds, coatings and encapsulations.

Easy to use 1 to 1 mix ratio. Difficult degassing procedures are not necessary. Just mix and pour.

Casting will be tack free in 5 minutes and completely cured in 15-30 minutes.

1533 can be used from -70 to +550°F and offers flexibility, excellent mechanical properties and resistance to chemicals, solvents and moisture.

Meets stringent UL 94V-0 flame retardant requirements.

Applications include: producing finely detailed molds, encapsulating electronic components, forming flexible parts and stress free potting.

Easy to use Flexible Putty

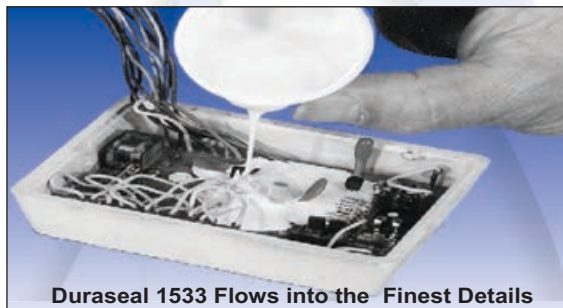
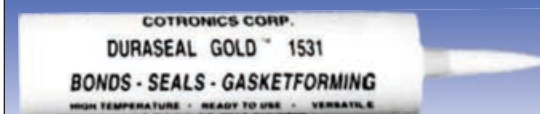

Duraseal 1533 Flows into the Finest Details

Product	1531	1532	1533
Max Intermittent Temp.	800°F	650°F	550°F
Continuous Service Temp.	650°F	500°F	500°F
Composition	Silicone	Silicone	Silicone
Viscosity (cps)	Putty	Putty	2,900
Toxicity	Low	Low	Low
Density (# /ft ³)	62.3	60	74
Elongation (%)	250	450	135
Hardness (Shore A)	31	18	20
Tensile Strength (psi)	275	225	580
Specific Heat (BTU/# °F)	0.35	0.35	0.35
Dielectric Constant (@ 10 ⁸ cps)	3.90	3.90	3.90
Volume Resistivity (ohm-cm)	10 ¹¹	10 ¹¹	10 ¹⁵
Dielectric Strength (volts/mil.)	500	550	500
Thermal Conductivity* (@ 500 °F)	2.00	1.20	1.50
Solids Content (%)	98	98.5	100
Shrinkage (%)	1.00	1.40	0.50
Shelf Life (months)	6	6	6
Tack Free Time (min.)	30	25	5
Full Cure Time (hrs. ¼" Bead)	24	24	15-30 (min)
Color	Gold	Clear	Green

Cat. No.	Description
Duraseal 1531-1.....	3 oz. Dispenser Tube
Duraseal 1531-2.....	11 oz. Caulking Cartridge
Case Pack.....	12-11 oz. Caulking Cartridges
Duraseal 1532-1.....	3 oz. Dispenser Tube
Duraseal 1532-2.....	11 oz. Caulking Cartridge
Case Pack.....	12-11 oz. Caulking Cartridges
Duraseal 1533-1.....	1 Pound Kit
Duraseal 1533-2.....	4 Pack - 50 cc Twin Packs
	(as shown on page 18)

COTRONICS RESBOND HIGH TEMP. ADHESIVE PROPERTIES

The following criteria is useful in selecting the optimum ceramic adhesive.
 These criteria are offered as a general guide and should be followed in the approximate order listed.
 A final manufacturing selection is then based on the results obtained.
 If several adhesives are indicated for a specific application, we would recommend a comparative evaluation be made.

1. Choose maximum temperature required.
2. Match thermal expansion between materials to be bonded.
3. Select the required electrical properties.
4. Select the bond strength requirements.
5. Check for porous surfaces (is a primer or pre-coat required).
6. Check moisture or humidity requirements.
7. Choose from the following manufacturing requirements:
 - A) One component, cures by evaporation.
 - B) Two component, chemical set.
 - C) Viscosity and Dispensability.
 - D) Cure time for handling strength.
 - E) Production Requirements.

Composition	Alumina				Zirconia	Zircon	Mica	Magnesia	Silica	Graphite	Metallic			
Resbond™	901	903HP	908	920	989	940	907	906	905	940LE	7030	950	952	954
Descriptions	Fiber Base	Hi-Bond Strength	Moisture Proof	Therm. Cond.	General Purpose	Ultra Temp.	Industrial Strength	High Expan.	Low Expan.	Fast Set	High Strength	Alum. Metal	Nickel Metal	Stainless Steel
Service Temp (°F)	3,000	3,000	3,000	3,000	3,000	4,000	2,300	3,000	2,500	2,500	1,800	1,200	2,000	2,000
Base	Al ₂ O ₃	Al ₂ O ₃	Al ₂ O ₃	Al ₂ O ₃	Al ₂ O ₃	ZrO ₂	MICA	MgO	SiO ₂	SiO ₂	SiO ₂	Al	Nickel	316SS
Comprehensive Strength (psi)	1,200	7,000	3,000	4,500	3,000	6,000	3,500	3,000	3,200	3,500	5,000	4,000	5,000	4,500
Flexural Strength (psi)	600	3,500	1,100	450	1,100	3,000	1,250	1,500	2,100	2,100	1,450	3,000	3,000	2,500
Thermal Expansion (10 ⁻⁶ / °F)	4	4	4.5	4.5	4.5	4.1	4.5	7	0.3	0.4	7.5	10	4	10
Thermal Conductivity (BTU - in/ Hr. ° F Ft ²)	2	40	15	15	15	15	6	40	10	5	8.3	44	14	10
Dielectric Strength (volts / mil)	200	250	200	270	200	250	300	250	200	125	100	COND.	COND.	COND.
Volume Resistivity (ohm-cm)	10 ¹²	10 ¹⁰	10 ¹⁰	10 ¹¹	10 ⁸	10 ⁸	10 ⁹	10 ⁹	10 ¹¹	10 ⁸	10 ⁹	COND.	COND.	COND.
Components	1	1	2	2	1	1	1	2	2	2	2	2	2	2
Mix Ratio	N/A	N/A	100/33	100/14	N/A	N/A	N/A	100/42	100/60	100/45	100/20	100/60	100/120	100/25
Consistency	Paint	Paint	Paste	Paste	Paint	Paint	Paste	Paste	Paste	Paste	Paste	Paste	Paste	Paste
Page Number	51	26	26	29	27	32	30	28	28	31	30	32	33	33

RESBOND™ CERAMIC ADHESIVES

Structural, Electrical and Metallurgical Applications



Resbond 904



Thermeez 7030



Durabond 950



Resbond 940LE



Resbond 989

Resbond Ceramic Adhesives are based on high purity, ceramic binders and selected reinforcing fillers. They were designed to satisfy the most difficult, high temp. application requirements.

These adhesives have excellent adhesion to ceramics, metals, glass and plastics and offer excellent high temp. stability, dielectric strength, mechanical properties and thermal shock resistance.

They are resistant to molten metals, oxidizing and reducing atmospheres, most chemicals and solvents.

Just mix and cure at room temp. No objectionable odors, VOCs' or outgassing.

Resbond adhesives are available in a wide range of temperature capabilities, viscosities, strengths, expansion rates, conductivities, and dielectric strengths.

They are the ideal choice for research, electronics, metallurgical, nuclear and industrial applications.

They are easily cured at room temperature without objectionable odors, VOCs' or outgassing.

- **Bond** Ceramic to ceramics, metals, or glass for high temp. structural bonds.
- **Impregnate** Insulator parts for electrical components, appliances, heaters, etc.
- **Coat** Metals, ceramics, glass, cloths, windings, etc.
- **Electronics** Encapsulation, resistors, high intensity lamps, fiber optics.
- **Equipment** Bonding door gaskets, thermocouples, furnace parts, feed thrus, vacuum equipment, seals, etc.
- **Appliances** Seals thermocouples, bonds heating elements, etc.
- **Instrumentation** Bonds and coats coil forms, fiber optics, strain gauges, etc.
- **Production** Light bulbs, gas ignitors, automotive sensors, end seals, catheters, threadlocking, etc.

970N Resbond Structural & Electrical Specialty Adhesive Selector Kit

Seven High Temperature Adhesives
in Convenient 4 oz. Bottles
Ideal for Simplifying
Product Evaluation and Selection



Each Kit Contains:

Cat. No.	Description	Use For	Temp.	Pg. No.
Resbond 901.....	Fiber Based Alumina.....	Bonding and coating porous materials	2300°F	24, 51
Resbond 907GF.....	Gasket Former/Adhesive.....	Sealing, bonding filling	2350°F	24, 38
Resbond 919.....	Electrically Resistant.....	High resistance, encapsulating and bonding	2800°F	24, 29
Resbond 989.....	General Purpose Alumina.....	Coating and bonding	3000°F	24, 27
Resbond 940.....	Fast Setting Ceramic.....	Strong bonds, available in custom grades	2000°F	24, 31
Durabond 950.....	Metallic Aluminum.....	High thermal conductivity and machinability	1200°F	24, 33
Thermeez 7030.....	Strong, Epoxy-Like Ceramic.....	Bonding, coating, high expansion applications	1800°F	24, 30

ALUMINA BASED ADHESIVES

Cures at Room Temp. to Bond, Pot, Seal and Protect

3000°F - RESBOND™ 908

Electrically Resistant - Thermally Conductive

New, High Purity, Alumina based adhesive incorporates a unique, catalytic curing system.

Just mix the adhesive and it's activator to form a readily dispensable, smooth, creamy paste.

It will not clog delicate dispensing needles and is suitable for any application requiring micro drops or several ounces of material.

Resbond 908 has excellent electrical resistance, moisture resistance and thermal conductivity.

Resbond 908 will become water insoluble after use (or post cure) at temperatures of 250°F - 300°F.

Users Report:

- 908 Successfully filled a long tubular probe, providing long term electrical isolation and moisture proofing for a electronic sensor.

Applications include bonding, potting and encapsulating delicate electronic assembles, sensors, instruments and general purpose high temp. applications.

It will satisfy many difficult application requirements and is ideal for many critical, electronic applications.



908 Bonds & Protects Sensors



903HP Bonds a High Strength Ceramic Fitting for use at 2650°F

3250°F - RESBOND™ 903HP

Bonds Dense Hi Strength Ceramics

Resbond 903HP is an ultra high temperature, Alumina Adhesive.

Developed for high strength bonding of any combination of dense non-porous ceramics, glass and or non-reactive metals.

Resbond 903HP is a smooth, creamy paste that can be brushed, troweled or sprayed on.

Just re-mix and apply.

Handling strength is obtained, after an initial cure at 250°F. A complete cure occurs in 1 hour at 600-700°F.

Resbond 903HP is usable to 3250°F continuously.

It has excellent resistant to liquid metals, oxidizing and reducing atmospheres, most chemicals and solvents.

Resbond 903HP has excellent electrical properties.

Users Report:

- 903HP bonds thermocouples to high alloy steel and withstands repeated thermal cycling from -100°F to 500°F.
- 903HP was easily sprayed onto stainless steel to form a dielectric layer for an industrial heater, used at 1400°F.

Resbond™	903 HP	908
Continuous Use Temp.	3250°F	3000°F
Base	Al ₂ O ₃	Al ₂ O ₃
Compressive Strength (psi)	7000	3000
Flexural Strength (psi)	3500	1100
Thermal Expansion (x10 ⁻⁶ /°F)	4.00	4.50
Thermal Cond. (BTU-in/Hr. Ft ² F)	40	15
Dielectric Strength (volts/mil)	250	200
Volume Resistivity (ohm-cm)	10 ¹⁰	10 ¹⁰
Components	1	2
Color	White	White
Consistency	Paint	Paste
Cure Temp.	600°F	R. T.

Availability:

Cat. No.	Description
Resbond 903HP-1.....	Pint
Resbond 903HP-2.....	Quart
Resbond 903HP-3.....	Thinner (Pint)
Resbond 908-1.....	Pint
Resbond 908-2.....	Quart

HI-TEMP ADHESIVES

Single Component - Alumina

3000°F - RESBOND™ 989 Alumina Adhesive

Resbond 989 is a one component high purity, 3000°F Alumina based, general purpose adhesive.

It has a smooth creamy consistency and cures at room temperature to form strong bonds to ceramics, graphite, metals and glass.

Resbond 989 is resistant to oxidation, electricity, molten metals, most chemicals and solvents.

Easy to use, Just apply and air dry.

Curing may be accelerated with mild heat.

Users Report:

- Bonds Silicon Carbide nozzles into alumina sleeving in a high temperature instrument chamber.
- Bonds Nickel pins, measuring 0.03" dia. into 0.04" holes in an aluminum nitride ceramic. These parts were quenched (from 900°C) in liquid Nitrogen without failure.
- Bonds Kanthal to Mullite tubes, forming inexpensive custom sized and durable high temp. Heating elements.

Applications Include: bonding alumina, metals, ceramics, graphite, electrical components, adhering thermocouples, heat sensors, and critical electronic components, in appliances, instruments, etc.

3000°F - RESBOND™ 989FS Fast Set Alumina Adhesive

New, 989 Fast Set is specially formulated for applications requiring a fast setting, single component, alumina adhesive.

Now, a free flowing formulation that is ideal for use in automatic dispensing equipment. It is precisely dispensed through fine needles with out clogging or mess.

Resbond 989FS cures at room temp. or in 5 minutes at 200°F.

It is the ideal choice for high speed production applications where automation is required.

3000°F - RESBOND™ 989F Pre-Nano Adhesive

The Alumina used to formulate Resbond 989F particle size has been reduced to 600 nms.

Resbond 989F combines this ultra-fine Alumina with special high temperature colloidal ceramic binders to create an adhesive ideal for a new generation of applications.

Resbond 989F can be used in the finest dispensers. No clogs. No mess. It is an ideal choice for high temp. production applications.

Now, there are no limits to applications requiring a high temperature alumina adhesive and the ability to bond super fine electric components, bundles of fiber optics filaments, cable end seals, components with tight tolerances.

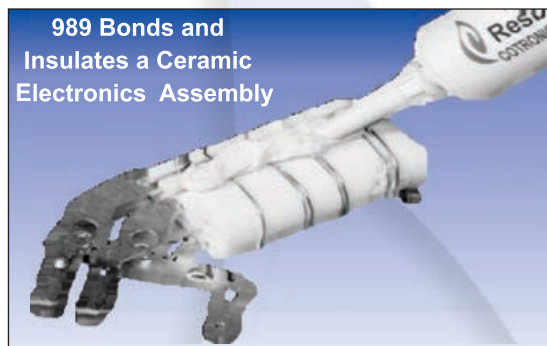

989 Bonds and Insulates a Ceramic Electronics Assembly



989 Rebuilds a Worn Ceramic Part for use to 2800°F

Resbond™	989	989FS	989F
Continuous Use Temp.	3000°F	3000°F	3000°F
Base	Al ₂ O ₃	Al ₂ O ₃	Al ₂ O ₃
Feature	General Purpose	Fast Set	0.6 Micron Ultra Fine
Compressive Strength (psi)	3000	3500	2800
Flexural Strength (psi)	1100	1250	950
Thermal Expansion (x 10 ⁻⁶ /°F)	4.50	4.50	4.50
Thermal Cond. (BTU-in/Hr. Ft ² -F)	15	15	12
Dielectric Strength (volts/mil)	200	200	200
Volume Resistivity (ohm - cm)	10 ⁸	10 ⁸	10 ⁸
Components	1	1	1
Color	White	White	White
Consistency	Paint	Paint	Cream
Cure @ R.T. (Hours)	2 - 4	½ - 2	2 - 4
Cure @ 200°F (Hours)	½ - 1	5 mins.	1 - 2

Availability

Cat. No.	Description
Resbond 989-1	Quart
Resbond 989-2	Gallon
Resbond 989T-1	Thinner (Pint)

NEW 989 FAST SET

Resbond 989FS-1	Pint
Resbond 989FS-2	Quart

NEW 989 ULTRA FINE

Resbond 989F-1	Pint
Resbond 989F-2	Quart

Production Pricing is Available upon Request

SPECIAL PURPOSE HI-TEMP ADHESIVES

For Electronic and Metallurgical Applications

2500°F - RESBOND™ 905

Low Expansion Adhesive

Resbond 905 Quartz (fused silica) Adhesive was specially formulated for bonding low expansion and thermal shock resistant ceramics.

The thermal expansion of Resbond 905 closely matches the extremely low expansion of Quartz, Fused Silica, Corderite and Lithium-Alumina Ceramics.

These shock resistant ceramics can now be successfully bonded and used to 2500°F.

Replaces standard ceramic adhesives that may crack and weaken on thermal cycling.

Just apply and let dry. Resbond 905 is resistant to most chemicals and solvents.

Users Report:

- Resbond 905 bonds and electrically insulates quartz light bulbs and fixtures.
- Resbond 905 bonds quartz to stainless steel to aid in processes designed to cool hot silicone.
- Resbond 905 successfully bonds colored glass panels to a halogen lamp, creating a crack resistant decorative lamp.



905 Bonds a High Performance Quartz Lamp



906 Bonds a Stainless Assembly

3000°F - RESBOND™ 906

High Expansion Adhesive

Resbond 906 Magnesia Based Adhesive was formulated for bonding high expansion materials for use to 3000°F.

Bonds to steel, stainless, aluminum, brass, copper, silver, nickel and other high expansion materials.

Resbond 906 will cure at room temperature to form a highly thermally conductive bond.

Strength and moisture resistance will be improved by a post cure at 600°F - 700°F.

Resbond 906 has excellent resistance to oxidizing and reducing atmospheres, most chemicals and solvents.

It is resistant to flame impingement and most liquid metals.

Users Report:

- 906 forms a thermally conductive and electrically insulating bond for Hi - Watt Density Heater.
- Coated Hi - Watt density heating coils before insertion into stainless steel tubes. Did not crack when exposed to vibration and high temperatures.
- Bonded re-crystalized alumina tubes to PTFE insulated cable for use at 700°F.

Applications include bonding high expansion materials, forms highly thermally conductive bonds, potting and encapsulating heating assemblies. etc.

Resbond™	905	906
Major Constituent	QUARTZ	MAGNESIA
Temp Limit	2500°F	3000°F
Thermal Expansion (x 10 ⁻⁶ /°F)	0.30	7
Thermal Conductivity (BTU-in/Hr. Ft ² °F)	10	40
Compressive Strength (psi)	3200	3000
Flex. Strength (psi)	2100	1500
Dielectric Strength (volts/mil)	200	250
Volume Resistivity (ohm - cm)	10 ¹¹	10 ⁹
Components	2	2
Mix Ratio	100/60	100/42
Color	White	White
Consistency	Paste	Paste

Cat. No.	Description
Resbond 905-1	Pint
Resbond 905-2	Quart
Resbond 905T-1	Thinner - Pint
Resbond 906-1	Pint
Resbond 906-2	Quart
Resbond 906T-1	Thinner-Pint

Production Pricing is Available Upon Request

ELECTRICALLY RESISTANT ADHESIVES

Room Temp. Cure, Use to 3000°F

2800°F - RESBOND™ 919

Electrically Resistant Adhesive

Resbond 919 was formulated with Cotronics' proprietary ceramic binders to offer an adhesive with exceptionally high electrical resistance.

These special binders maintain their high electrical resistance and dielectric strength even when exposed to temperatures up to 2800°F.

Resbond 919 has a dielectric strength of 270 volts/mil and a volume resistivity of 10^{11} ohm-cm (at room temp.).

Just mix the 919 to a creamy paste, apply and dry at room temperature.

Users Report:

- Bonds electrode rods into electrically insulating ceramic tubes and protects them from voltage breakdown and corrosive atmospheres.
- Seals light bulb fixtures, insulating them with out cracking when exposed to heat and thermal cycling.
- Forms protective tubes for fiberglass covered extension wires. Protecting against heat and corrosion.

Resbond 919 is commonly used for electrical insulation when potting, sealing or coating, ignitors, thermocouples, heating coils, instrumentation, etc.



Applying 919 to a Hi-Power Resistor



920 Provides a Thermally Conductive and Electrically Insulating Bond

3000°F - RESBOND™ 920

Thermally Conductive Adhesive

Resbond 920 offers both high thermal conductivity and the superior electrical resistance of Resbond 919.

It is based on conductive Alumina ceramic and should be used whenever rapid dissipation of heat is required.

Resbond 920 has a dielectric strength of 270 volts/mil, volume resistivity of 10^{11} ohm-cm (at room temp.) and a thermal conductivity of 15 BTU in/°F hr. sq. ft.².

It offers excellent electrical, chemical and solvent resistance.

Resbond 920 is easy to use. Just mix, apply and cure at room temperature. Cures can be accelerated with mild heat (when required). Resbond 920 is easily incorporated into many production processes.

Users Report:

- Resbond 920 Replaced seven (7) different adhesives, and potting compounds, at a heating element manufacturers plant for use in various applications from - 60°C to 1500°C.

Applications Include Bonding high temperature resistors, pyrometers, heating elements, furnace elements, etc.

Resbond 920 is ideal for use in applications where a combination of high electrical resistance and good thermal conductivity is required.

Resbond™	919	920
Continuous Use Temp.	2800°F	3000°F
Base	MgO	Al ₂ O ₃
Form	Paste	Paste
Compressive Strength (psi)	4500	4500
Flexural Strength (psi)	450	450
Thermal Expansion (x10 ⁻⁶ /°F)	2.60	4.50
Thermal Cond. (BTU-in/Hr. Ft ² -°F)	4	15
Dielectric Strength (volts/mil)	270	270
Volume Resistivity (ohm - cm)	10 ¹¹	10 ¹¹
Components	2	2
Mix Ratio	100/13	100/14
Color	Tan	White
Consistency	Paste	Paste

Cat. No.

Resbond 919-1.....	Quart
Resbond 919-2.....	Gallon
Resbond 920-1.....	Quart
Resbond 920-2.....	Gallon

Description

HIGH TEMPERATURE ADHESIVES

Room Temp. Cure - Use to 3000°F

1800°F - THERMEEZ™ 7030

Epoxy Like Adhesive

Thermeez 7030 High Expansion Adhesive Bonds and Protects to 1800°F.

Asbestos free and safe to use.

No objectionable odors or harmful fibers.

Just mix to a smooth, creamy paste and apply.

Thermeez will cure in 24 hours at room temperature or in 1 hour at 250 °F.

Can be applied to most metals, ceramics, door gaskets, tadpole gaskets and ceramic cloths and has excellent adhesion to steel, stainless, aluminum, lead and ceramics.

Thermeez 7030 is fireproof and has resistance to most acids, alkalis, solvents, corrosives and electricity.

Thermeez Hi-Seal will form corrosion and erosion resistant coatings. Just apply and post cure at 600°F.

Can be applied from a standard caulking cartridge for applications in exhaust systems, diesel engines, gas turbines, heating plants, etc.

It is the ideal choice for any hi-temp. application requiring 1800°F service, pressure tight and fire proof seals, wear resistance and high expansion.

Commonly used in high temperature exhaust systems, diesel engines, gas turbines, heating plants, etc.



Thermeez 7030 Seals a Corrosion Resistant Exhaust System



Resbond 907 Bonds a Hi-Temp. Gas Supply Tube

2300°F - RESBOND™ 907

All Purpose Fire Proof Adhesive

A Single Component Ceramic Composite based on Mica platelets and proprietary ceramic binders.

Resbond 907, all purpose adhesive offers high bond strength, solvent and electrical resistance.

Safe to use. No objectionable or toxic odors.

Use from -300°F to +2300°F.

Resbond 907 was developed to provide a Fire Proof Adhesive for applications in production, development, repair and maintenance.

Just apply directly to clean steel, iron, lead, ceramics, most metals, etc. without any special surface treatment.

Air dries in 24 - 48 hours at room temp. or in 1 hour at 250°F.

Users Report:

- Easy to use Resbond 907, Bonded exhaust tubes in an aerospace application, replacing a difficult to handle, corrosive adhesive with serious environmental problems.

Applications include exhaust systems, diesel engines, gas turbines, heating plants, bonding ceramic tapes, etc.

Thermeez / Resbond	7030	907
Continuous Use Temp.	1800°F	2300°F
Base	SiO ₂	Mica
Compressive Strength (psi)	5000	3500
Flexural Strength (psi)	1450	1250
Thermal Expansion (x10 ⁻⁶ /°F)	7.50	4.50
Thermal Cond (BTU-in/Hr. Ft ² °F)	8.30	6.00
Dielectric Strength (volts / mil)	100	300
Volume Resistivity (ohm - cm)	10 ⁹	10 ⁹
Components	2	1
Consistency	Paste	Paste
Cure @ 75°F (Hours)	24-48	24
Cure @ 250°F (Hours)	1	1

Cat. No.	Description	Temp.
7030-1.....	Quart	1800°F
7030-2.....	Gallon	1800°F
7030-3.....	5 Gallon	1800°F

907-1*.....	1.0 lbs. (½ pt).....	2300°F
907-2*.....	3.5 lbs. (qt).....	2300°F
907-3*.....	7 lbs. (½ gal).....	2300°F
907T-1.....	Thinner (qt).....

*(For 907 specify Thin, Regular or High Viscosity)

CUSTOMIZABLE, 2800°F ADHESIVES

Solves All High Temp. Bonding, Sealing or Encapsulating Applications



Production Potting of High Performance Light Bulbs



Resbond 940LE Bonds a High Performance Quartz Lamp



940HT Bonds a Sapphire Tube To a Metal End Cap for Use at 2650°F

Resbond™	940	940HT	940LE	940HE	940SS
Continuous Use Temp.	2000°F	2800°F	2500°F	1800°F	2000°F
Base	Zircon	Al ₂ O ₃	SiO ₂	SiO ₂	S. S.
Compressive Strength (psi)	4000	4200	3500	4200	4500
Flexural Strength (psi)	1800	1900	2100	1450	2500
Thermal Expansion (x10 ⁻⁶ /°F)	4.50	4.00	0.40	7.50	10
Thermal Conductivity (BTU-in/Hr. Ft ² °F)	8	15	5	8.3	10
Dielectric Strength (volts/mil)	125	125	125	100	Cond.
Volume Resistivity (ohm-cm)	10 ⁸	10 ⁸	10 ⁸	10 ⁹	Cond.
Components	2	2	2	2	2
Color	Tan	White	White	Tan	Grey
Consistency	Paste	Paste	Paste	Paste	Paste
Cure Temp.	R. T.	R. T.	R. T.	R. T.	R. T.

Now, for the first time, a Customizable Series of fast setting, 2800°F adhesives that were designed with your application in mind.

Eliminate costly errors caused by bonding adhesives and substrates with mismatched physical properties.

Just match the grade of Resbond 940 with the physical properties of the substrate. Mix and apply. Cures in five minutes at 175°F or in 16 hours at room temperature.

Applications include bonding, sealing and insulating, halogen lamps, fixtures, fiber optic cables, sensors, encapsulating, heating elements, electrically resistant coatings, high temp instruments, etc.

2000°F - Resbond 940 Standard

Has excellent adhesion to ceramics, glass, metals, etc. Offers excellent electrical, chemical and thermal shock resistance.

Users Report:

- Resbond 940 encapsulates industrial heating elements and high temperature sensors. Resbond outperformed all of the other ceramic adhesives and materials tested. Also used as an electrically resistant coating.

2800°F - Resbond 940HT High Temperature

Specially formulated, ultra high temp. Alumina adhesive that can be used continuously to 2800°F.

Resistant to liquid metals, most chemicals and solvents, oxidizing and reducing atmospheres.

1800°F - Resbond 940HE High Expansion

A silica filled adhesive for bonding and encapsulating high expansion materials.

Users Report:

- Resbond 940HE provided an insulating end seal for a heating element.

2500°F - Resbond 940 Low Expansion

New Resbond 940LE is a low expansion, Quartz based, fast curing adhesive.

The perfect adhesive for bonding and potting Quartz Lamps, Glassware, Fiber Cables or any other low expansion materials.

940LE bonded high performance, halogen light bulbs in a high speed, high precision production line.

2000°F - Resbond 940SS Stainless Steel

New Resbond 940SS is a 316 Stainless Steel based, fast curing adhesive with excellent adhesion and heat resistance.

This 2000°F, Stainless Steel Adhesive bonds, repairs and seals high temperature equipment.

It is machinable and resistant to most chemicals and solvents.

Cat. No.

Resbond 940	N/A	Quart Kit	Gallon Kit
Resbond 940HT-1	Pint Kit	Quart Kit	Gallon Kit
Resbond 940LE-1	Pint Kit	Quart Kit	Gallon Kit
Resbond 940HE-1	Pint Kit	Quart Kit	Gallon Kit
Resbond 940SS-1	Pint Kit	Quart Kit	Gallon Kit
Resbond 940-3	Thinner (Pint)				

Kit Sizes

Available Upon Request Fast Setting Aluminum, Aluminum Nitride, Bronze, Copper, or Silver formulations

ULTRA HI-TEMP ADHESIVES

For Electronic, Metallurgical and Structural Applications

4000°F - RESBOND™ 904

Zirconia Adhesive

Resbond 904 extreme temperature adhesive surpasses the capabilities of most materials to provide 4000°F service.

Resbond 904 is a smooth, creamy paste that is easily applied and air dried to form a hard surface.

Resistant to molten metals, most chemicals and solvents, oxidizing and reducing atmospheres.

It is ideal for bonding and forming electrical, oxidation erosion and liquid metal resistant coatings for ceramics, graphite and thermocouple tubes.

Users Report:

- Bonded exhaust lines to a Thermogravimetric Analyzer's reaction chamber and used at 3400°F under a vacuum.
- Bonded Silica Cloth to furnace tubes for use at 2600°F in a Semi-conductor's clean room.
- Coated Aluminum Metal Panels on a Spacecraft and successfully protected the metal panels from High Intensity X-Ray radiation.

Applications include welding, brazing, bonding, electrical seals, thermocouple protection, instruments, high temp. facing for brick, electrical potting, liquid metal handling, etc.

5400°F - 931 Graphite Adhesive

99% Pure Graphite

Resbond 931 bonds Graphite or carbon components for use to 3000°C with 99% pure graphite. Just apply and cure at 250°F.

931 has excellent adhesion to graphite, and other porous surfaces, forming graphite to graphite bonds with strengths measuring in excess of 2500 psi.

It is electrically conductive and resistant to reducing atmospheres, most chemicals and solvents.

Resbond 931 is ideal for repairing broken or cracked graphite trays, components, fixtures, dies; filling and rebuilding crevices, cracks, worn areas and bonding graphite cloths, felts, boards, etc.

Users Report:

Resbond 931 repaired a 20" dia. x 24" high, cracked, induction heating susceptor. The susceptor heated uniformly after the repair. Resbond 931 Graphite adhesive doubled the life of this expensive part.

2500°F - 931C Ceramic Bonded Graphite

Resbond 931C has excellent adhesion to graphite, metals, glass, ceramics and non-porous parts. Its easy, just re-mix, apply and let dry. 931C cures at room temp. without heat.

Graphite Sealer

Resbond 931S Sealer can be used to reduce porosity, seal surfaces and increase the wear resistance and durability of graphite parts.

Users Report: Resbond 931S sealed the porous surface of graphite parts doubling the life of heat treating trays. 931S stopped dusting of graphite fixtures.



931 Forms a Pure Graphite bond in a Complex Graphite assembly

Resbond™	904	931	931C
Major Constituent	Zirconia	Graphite	Graphite
Maximum Temp	4000°F	5400°F*	2500°F*
Purity %	95	99	90
Thermal Expansion (x10 ⁻⁶ /°F)	4.10	4.10	4.10
Thermal Conductivity (BTU-in/Hr. Ft ² °F)	10	60	40
Compressive Strength (psi)	6000	3000	4200
Flex. Strength (psi)	3000	1500	1800
Dielectric Strength (volts/mil)	250	Conductive	Conductive
Color	Tan	Black	Black
Components	1	2	1
Mix Ratio	N/A	100/35	N/A
Cure @ R.T. (Hours)	2-4	1-2 @ 250	2-4
Consistency	Paint	Paste	Paste

*Inert Atmosphere

Cat No.

Cat No.	Size
Resbond 904-1.	Pint
Resbond 904-2.	Quart
Resbond 904-4.	Thinner (Pint)
Resbond 931-1.	Pint
Resbond 931-2.	Quart
Resbond 931-3.	Gallon
Resbond 931-4.	Thinner (Pint)
Resbond 931S-1	Sealer (Pint)
Resbond 931C-1	Pint
Resbond 931C-2	Quart
Resbond 931C-3	Thinner (Pint)

UNIQUE METALLIC ADHESIVES AND PUTTIES

High Bond Strength, Thermal Shock and Impact Resistance

DURABOND™ 950 - 952 - 954 2000°F Metallic Adhesives

Durabond Adhesives and Putties were specially formulated to bond metals, ceramics and dissimilar materials for use to 2000°F.

These metallic composite adhesives overcome the brittle bonds obtained with ceramics and offer some of the ductility and impact resistance associated with soldering and welding. Durabond adhesives can be drilled, tapped, machined, etc.

They do not contain Epoxies or Silicones which would limit their use to 600°F.

These composites are inorganically bonded and chemically cured.

They are safe and easy to use. No odors. No VOC's.

Just mix, apply and cure at room temperature.

Fast Setting Durabond Composites (type FS) are now available. These smooth, creamy, putties are ideal for repairs, patching, casting, potting, etc.

Durabond™	950	952	954
Use Temp	1200°F	2000°F	2000°F
Base	Aluminum	Nickel	Stainless
Color	Grey	Grey	Grey
Density (# / ft ³)	120	180	180
Thermal Expansion (10 ⁻⁶ /°F)	10	4	10
Pot Life (Hours)	2	2	2
Bond Strength @ 200°F (psi)	500	400	600
Bond Strength @ 1200°F (psi)	1000	1200	1400
Components	2	2	2
Mixed Ratio (A / B)	100/60	100/120	100/25
Cure @ R.T. (Hours)	24	24	24

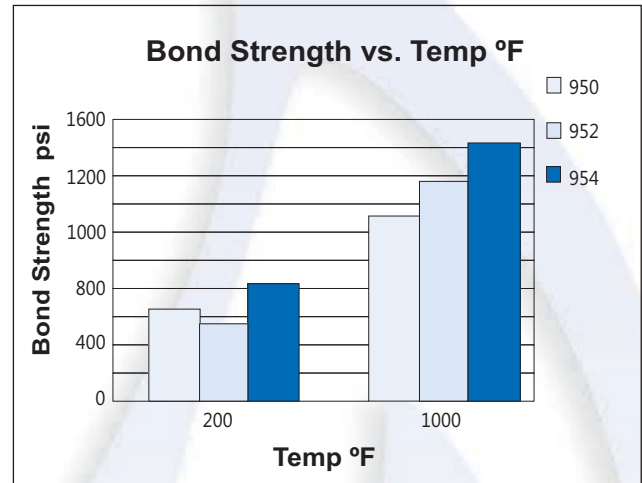

Durabond 954 Bonds a Stainless Filter Cartridge for use at 1200°F

Aluminum Durabond 950 - Usable to 1200°F

This adhesive was developed for high strength and high temp. bonding. Its easy to apply and cures at low temp. Use with steel, cast iron, aluminum, copper, etc.

Its easily machinable. Can be ground, sanded or polished.

Nickel Durabond 952 - Usable to 2000°F

952 was specially formulated to be a low expansion, metallic adhesive for bonding 400 series Stainless Steel, low expansion high temp. alloys, metals and ceramics, etc.

Stainless Steel Durabond 954 - Usable to 2000°F

954 is a high expansion adhesive for high temp. bonding of 300 series Stainless, high expansion metals, ceramics, etc.

NEW, Stainless Steel, Sealing Adhesive - Usable to 2000°F

954OD bonds and seals high expansion materials. Ideal for applications requiring the minimum porosity from a ceramic adhesive. Commonly used to prevent leaks from equipment.

Cat. No.	Base	Type	Size
950-1	Aluminum	Adhesive	Pint
950-2	Aluminum	Adhesive	Quart
950FS-1	Aluminum	Putty	Pint
952-1	Nickel	Adhesive	Pint
952-2	Nickel	Adhesive	Quart
952FS-1	Nickel	Putty	Pint
954-1	Stainless	Adhesive	Pint
954-2	Stainless	Adhesive	Quart
954FS-1	Stainless	Putty	Pint
954OD-1	Stainless	Sealer	Pint
954OD-2	Stainless	Sealer	Quart

Now Available, Pre-Measured Kits
Ideal for Field Applications

DURAPOT™ CERAMICS

Potting Compounds - Cure at Room Temp. - Use to 3000°F

Durapot™	801	804	805	809	810	814	820	821
SPECIAL FEATURE	Pure Alumina	Small Parts	Large Castings	High Dielectric	Thermal Cond.	Fast Cure	Dielectric Coating	Low Expansion
BASE	99% Alumina	96% Alumina	96% Alumina	MgO Base	Alumina	Zirconia Silicate	Alumina Oxide	Fused Silica
Temp Limit °F	3350	3000	3000	2800	3000	2000	3000	2500
Volume Resistivity (ohm-cm)	10 ¹⁵	10 ¹⁰	10 ¹⁰	10 ¹¹	10 ¹¹	10 ⁸	10 ¹²	10 ⁸
Dielectric Strength (volts/mil)	350	175	175	270	270	125	200	125
Thermal Expansion (10 ⁻⁶ /°F)	4.30	4	4	2.60	4.50	4.50	4	0.30
Thermal Conductivity (BTU-in /°F.Hr.Ft ²)	8	8	10	4	15	8	2	5
Chemical Resistance	Good	Good	Good	Good	Good	Good	Good	Excellent
Solvent Resistance	Excellent	Excellent	Excellent	Excellent	Excellent	Excellent	Excellent	Excellent
Pot Life	15 min.	30 min.	30 min.	20 min.	20 min	20 min	10 min.	20 min
Components	2	2	2	2	2	2	1	2
Color	White	White	White	Tan	Tan	White	Red	White
Mix Ratio Base	100 parts	100 parts	100 parts	100 parts	100 parts	100 parts	one component	100 parts
Activator	44 parts	19 parts	12 parts	13 parts	13 parts	30 parts		44 parts
Cure Cycle Time **	24 hrs.	24 hrs.	24 hrs.	24 hrs.	24 hrs.	24 hrs.	24 hrs.	24 hrs.
	R. T.	R. T.	R. T.	R. T.	R. T.	R. T.	R. T.	R. T.

**NOTE: Cure may be accelerated by mild heating @ 150°F - 200°F.
Post cures @ 250°F will improve moisture resistance for 801, 808, 809, 814,821.

High Temp, High Resistance Encapsulating and Embedding Materials

Durapot 801 99% Pure Alumina Ceramic

Durapot 801 is a specially formulated, room temperature curing, 99% Pure Alumina Ceramic that offers the ultimate properties of pure Alumina.

No binders to contaminate even the most delicate systems. Offers high electrical resistance even at high temperatures.

This unique 99% Pure Alumina Ceramic finds uses in many electrical and metallurgical applications.

Durapot 804 and 805 96% Pure Alumina Ceramic

Durapot 804 and 805 were formulated to provide a high strength, low cost Alumina potting and casting material.

Electrical and metallurgical properties are excellent.

Simply mix, pour and cure at room temperature.

Use Durapot 804 for small parts and 805 for large parts.



Encapsulating Electronic Components

Durapot 809 Electrically Resistant Cement

The best, general purpose ceramic potting compound. Durapot 809 is a 2800°F, highly electrically resistant ceramic.

Use for potting, sealing and bonding. Just mix, apply and cure at room temperature.

Use in ignitions, heating coils, electronics and many production applications.

Durapot 810 Thermally Conductive and Electrically Resistant Cement

810 is a 3000°F, highly thermal conductive, electrically resistant Alumina based, potting compound and adhesive that was developed to provide excellent electrical resistance at high temperatures and improved thermal conductivity for high power applications.

Choose regular grade for maximum thermal conductivity or extra fine for small parts.

Durapot 814 High Speed Potting Cement

Durapot 814 was formulated for use where a fast cure is required. Just mix and apply. Will cure in 5 minutes at 175°F - 225°F or overnight at room temperature. It is an excellent choice for production applications.

Durapot 820 Electrically Resistant Coating

A one component paint and coating. Just brush on and air dry to form a highly resistant, 3000°F coating containing over 85% Alumina. Use to coat wires, coils etc.

Durapot 821 Low Expansion Cement

Durapot 821 is a Quartz based, fast curing adhesive and potting compound.

The perfect material for bonding and potting Quartz Lamps, Glassware, Fiber Cables or any low expansion material.

It is easy to use and allows fast cures when required. Ideal for use in production applications.

Cat. No.	Description	Kit Sizes
Durapot 801.....	Powder & Activator	Quart Gallon
Durapot 804.....	Powder	Quart Gallon
Durapot 805.....	Powder	Quart Gallon
Durapot 809.....	Powder	Quart Gallon
Durapot 810.....	Powder	Quart Gallon
Durapot 814.....	Powder & Activator	Quart Gallon
Durapot 820.....	Paint	Quart Gallon
Durapot 821.....	Powder & Activator	Pint Quart

Quantity Pricing Available Upon Request

HI-TEMP SEALANTS AND COATINGS

Low Cost, Stock Sizes, Ideal For 1000's of Applications

DURALCO™ High Temp Coatings

Duralco 230N
Protects an
Igniter
Housing

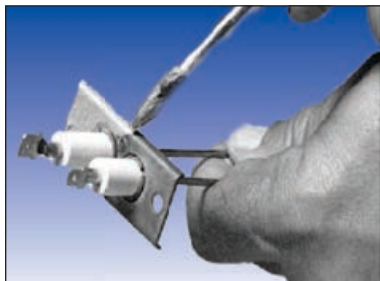

Cat. No.	201	215	230	254
Base Binder	Aluminum Ceramic	Alumina Ceramic	SS Ceramic	SS Glass
Temp. Max	1200	2500	1500	1800
Cure °F Initial	175	RT	RT	RT
Cure °F Final	600	NR	250	1400
Color	Grey	White	Stainless	Gray
Pts.	108.13	N/A	104.95	104.45
Qts.	185.63	106.31	188.21	193.88
Gals.	395.12	270.11	411.23	427.08

1200°F - Duralco 201 - Liquid Aluminum Coating

Duralco 201 is a new, water based coating filled with ultra fine aluminum for maximum corrosion resistance. Duralco 201 has excellent resistance to high humidity and saline atmospheres, fuel gas exhaust, corrosive environments and organic solvents. Its easy to use. Just apply and cure.

Applications Include: protecting stacks, mufflers, boilers, jet engines, heat exchanges, chemical processing equipment, outdoor electrical equipment and other assemblies.

2500°F - Duralco 215 - Impregnate and Coating

Duralco 215 has ultra fine, ceramic particles that will impregnate even into pre-wound electric windings. It is readily applied by brushing, dipping, coating and air dries to provide excellent electrical, chemical and solvent resistance.

Applications Include: coating and impregnating high temp. coils, motors, transformers, resistors, heating elements, etc.

1500°F - Duralco 230 - Liquid Stainless Coating

Duralco 230 Liquid Stainless is formulated from specially processed, stainless steel platelets and Ceramic binders creating a safe, water based system. It is applied to clean surfaces by brushing, spraying or dipping. Air drying or mild heat will provide corrosion resistance to 1300°F -1500°F.

Users Report: Parts coated with Duralco 230 passed 2000 hour tests and thousands of thermal cycles tests to 1300°F.

1800°F - Duralco 254 - Porcelain Like Stainless

Duralco 254 is a unique, silicone bonded, porcelain like, highly protective, Stainless Steel, Composite Coating. Just apply and dry at room temp. Post cure at approximately 1100°F to 1400°F. Duralco 254 offers service up to 1800°F and is ideal for providing protection for all types of metallic surfaces.

DURASEAL™ High Temp Sealants

Duraseal 1529
Moisture-
Proofs
Porous
Ceramic
Components



DURASEAL+ BASE	1529 Silicone	1529H Catalyzed Silicone	1529FS Catalyzed Silicone	1529UHT Silicone/Glass Composite
Use Temp.	600 °F	750 °F	900 °F	1800 °F
Dielectric Strength v/mil	300	300	325	800
Color	Clear	Clear	Clear	White
Moisture	Excellent	Excellent	Excellent	Excellent
Chemicals	Good	Good	Good	Excellent
Cure Temp. °F	350	350	400	425 & Glaze @1100-1400
Pints	80.12	98.96	110.20	108.10
Quarts	123.69	144.74	159.60	154.56
Thinner Pints	39.38	39.38	39.38	39.38

Duraseal High Temperature Sealers

The ideal choice for waterproofing, sealing, impregnating and coating in any high temperature application.

Duraseal High Temperature sealants are based on organic-inorganic formulations and can be used up to 1800°F.

DURASEAL+ will increase dielectric properties, moisture proof and seal ceramics, thermocouples, cartridge heaters, end seals, etc.

Commonly used for waterproofing Cotronics' ceramic fiber products, high temp. gaskets, sleeving and tapes.

600-800°F - Duraseal+ 1529 and 1529H

Low viscosity liquid sealants that will readily penetrate porous surfaces and cure at 350°F.

900°F - Duraseal+ 1529 FS

A Low odor and VOC. formulation, medium viscosity sealant and coating for porous surfaces. Usable up to 900°F.

1800°F - Duraseal+ 1529 UHT

Now, for the first time, a silicone is combined with glass and a unique synergistic reaction forms a composite that will moisture-proof from room temperature to 1800°F.

Duraseal 1529 UHT dries at 250°F and glazes at 1200°F - 1400°F forming a surface for higher temperature applications.

HIGH TEMPERATURE SUPPLIES

Coatings and Anti-Seize

1200°F - DURALCO™ 6105SP

Stainless Spray Coating

Now the corrosion resistance of Stainless Steel in an easy to use, spray paint form.

Cotronics' unique room temperature curing, high temperature, resin system is combined with type 316L stainless steel flakes.

When sprayed, it forms a continuous layer of stainless steel to protect the underlying metallic surfaces. Cures at room temp. and protects up to 1200°F

Resistant to most chemicals and solvents. Ideal for coating high temp. equipment, pipes, stacks, boilers, furnaces.

Packaged in convenient 7 oz. spray cans. Coverage is approximately 30 ft.² / can.



1000°F - DURALCO™ 201SP

Aluminum Spray Coating

Duralco 201SP combines the corrosion resistance of Aluminum with the high temperature protection of Cotronics' specialty silicone binders to form a 1000°F protective coating.

Easy to use. Just shake, spray and dry.

Duralco 201SP cures at room temperature to form a protective coating with excellent chemical, corrosion, solvent and high temperature resistance.

Duralco 201SP fights corrosion to 1000°F.

It is ideal for coating high temperature equipment, pipes, stacks, boilers, heat exchanges, furnaces, etc.

Available in convenient to use 12 oz. spray cans. Just one can covers up to 30 square feet of metal.



1200°F - DURALCO™ 6105

Stainless Brush On Coating

Now, the corrosion resistance of 6105SP is now available in a new, easy to use, brush on form.

When applied it forms a continuous layer of stainless steel to protect the underlying metallic surfaces. Cures at room temp. and protects up to 1200°F

Resistant to most chemicals and solvents.

Commonly used for coating high temp. equipment, pipes, stacks, boilers, furnaces.

Duralco 6105 Stainless Steel Coating is ideal for large volume and production applications.

RESCOR™ 112 Boron Nitride Spray

Coating and Lubricant

Boron Nitride has excellent electrical insulation, high thermal conductivity and is a superior high temp. lubricant. It is inert to most molten metals, glasses and salts.

This unique combination makes for an ideal high temp. lubricant, mold release and electrically resistant coating.

Use continuously to 1500°F in air and to 3600°F in inert atmospheres.

Now available in a convenient and fast drying (Non Ozone Depleting) spray formulation.

Applications Include mold release, lubricant, barrier layer and as an anti-splatter compound in the metals, plastics, glass, composites and ceramic industries.



2400°F - DURALCO™ R450 Anti-Seize

No Galling ! No Pitting ! No Seizing !

R-450 Anti-Seize prevents metal to metal contact and eliminates failures often caused by corrosion, abrasion, strong acids and alkalis.

Allows for easy movement and disassembly.

Ideal thread lubricant for steel to stainless, brass to steel and dissimilar materials.

Use in power plants, chemical facilities, oil refineries, automotive, appliance, aerospace, etc.



Cat. No.	Description
Rescor 112-1.....	13 oz. Spray Can
Rescor 112-1C.....	12 - 13 oz. Cans
Rescor 112-BO-1.....	Brush-on Gallon
Duralco 6105SP-1.....	7 oz. Spray Can
Case Pack.....	12 - 7 oz. Cans
Duralco 201SP-1.....	12 oz. Spray Can
Case Pack.....	12 - 12 oz. Cans
Duralco 6105-1.....	Brush-on Pint
Duralco 6105-2.....	Brush-on Quart
Duralco 6105-3.....	Brush-on Gallon
No Seize R-450-1.....	4 oz. Brush Top Can
Case Pack.....	12 - 4 oz. Cans

2300°F ADHESIVE AND SEALANT PUTTY

Bonds, Seals, Fills and Protects

RESBOND™ 907GF

Resbond 907GF Fireproof Adhesive and Sealant is a moist, creamy putty for use from -300°F to 2350°F.

It is easily applied from standard caulking cartridges and air dries in 4- 12 hours at room temperature. (Curing may be accelerated with mild heat).

Resbond 907GF has excellent adhesion to clean steel, stainless, iron, most metals, ceramics, ceramic cloths, tapes, gaskets, tadpoles gaskets, etc.

Resistant to most chemicals, solvents, oxidizing and reducing atmospheres, aging, thermal cycling, and electricity.

Applications Include:

- **Bonds** - Ceramic tapes, metals, ceramics, glass, assemblies instruments, etc.
- **Repairs** - Exhaust systems, diesel engines, gas turbines, heating plant equipment, ceramics, fire bricks, mortar etc.
- **Assembles** - High temperature equipment, brazing fixtures, brazing supports, stacks, etc.
- **Seals** - Exhaust systems, stacks, flues, gaskets, fills surface irregularities, etc.

Users Report:

- Resbond 907GF seals exhaust ducts against corrosive chemicals and high temperatures.
- Resbond 907GF replaces ceramic gaskets and successfully seals pipe joints for use up to 1800°F.
- Resbond 907GF bonds over lapping layers of stainless steel to form air ducts for furnaces that operate at 1200°F continuously.

Packaged in convenient dispenser tubes and standard caulking cartridges.

Resbond 907GF is ideal for use in any high temperature Assembly, Production, Repair or Maintenance Application.

Availability:

Cat. No.	Description
Resbond 907GF-5.....	3-4 oz. Dispenser Tubes
Resbond 907GF-6.....	11 oz. Caulking Cartridge
Resbond 907GF-6CP	
Case Pack.....	12 - 11 oz. Cartridges
Resbond 907GF-7.....	Smooth, Fine Grade, 11 oz.
Resbond 907GF-1.....	1 lb. Container (1/2 pint)
Resbond 907GF-2.....	3.5 lbs. Container (quart)



907GF Seals Exhaust Ducts Carrying Corrosive Chemicals



Applying 907GF to a Flange Forming a Hi-Temp. Seal

Physical Properties	907GF
Max Use Temp.	3000°F
Continuous Service Temp. (°F)	2350
Density (# / ft ³)	65-80
Compressive Strength (psi)	1500
Elongation (%)	5
Specific Heat (BTU/# °F)	0.25
Dielectric Constant (@ 10 ⁸ cps)	3.00
Volume Resistivity (ohm-cm)	10 ⁹
Dielectric Strength (volts/mil.)	145
Thermal Cond. (BTU-in/Hr. Ft ² °F @ 500°F)	6.00
Shrinkage (%)	2
Shelf Life (Months)	6

Quantity Prices are Available Upon Request

HIGH TEMP. PUTTIES WON'T RUN, DRIP OR SAG

Just Mix, Apply and Cure at Room Temp.
Machinable Putties will Bond, Repair and Rebuild

These smooth, creamy putties combine the high temperature performance of Cotronics' specialty formulations with easy to use, dispensing systems ideal for most applications.

Non Sag Putties are ideal for use where the flow of an adhesive or repair material would limit their use. No need for clamps.

Just trowel on and cure at room temp. to repair, rebuild and assemble components.

These self measuring and dispensing systems are ideal for small jobs, field use, in-house repairs and even production applications.

Epox-Eez™ RK 454 500°F Machinable Aluminum Putty

Just dispense, mix and apply. This smooth, creamy putty cures at room temp. to form a highly machinable, aluminum based composite. Usable to 500°F.

RK454 offers excellent adhesion, corrosion and chemical resistance. The comparative strength at elevated temperatures is shown on the adjacent graph.

Epox Eez RK454 is ideal for patching leaky pipes, valves and fittings; repairing pumps, machinery and equipment; and rebuilding worn shafts, housings and linings. Used to fill holes prior to powder coating. It is commonly used in appliances, automotive, electronic, instrumentation, motors, chemical equipment, etc. A must for every shop and laboratory.

Applicator Kit (Rk454)

One Pound Kit (454B-1)

Now Available, Stainless Steel Based, Epoxy Repair Putty

Applicator Kit (Rk456)

One Pound Kit (456B-1)

Durabond™ 7025 New 1000°F Aluminum Putty

Now available, Durabond 7025 Corrosion Resistant Putty specially formulated with active aluminum metal to provide excellent resistance to corrosion, erosion, most chemicals and solvents.

Packaged in easy to use kits. Just mix to a smooth creamy putty and apply.

This creamy paste is easily troweled on to form a smooth surface that is ideal for any high temp. repair, rebuilding, production, manufacturing, industrial, automotive or equipment application.

Durabond 7025 cures in 24 hours at room temp. or in 2 hours at 250°F to form a highly machinable, aluminum based composite usable to 1000°F.

Applications Include: Rebuilding worn or eroded areas, repairing cracks and voids; sealing and protecting process equipment, rebuilding worn pumps, impellers, valves, motors, heat exchanges, etc.

One Pound Kit (7025-1)

Two Pound Kit (7025-2)

Durabond™ 7032 New 2000°F Stainless Putty

Now, a 2000°F Stainless Steel putty that will repair and seal high temperature equipment with the ease of Cotronics' high performance systems.

A smooth creamy paste, just trowel on and cure at room temperature. Will not run, drip, or sag.

Safe to use. No flammable solvents. No harsh odors. Hardening starts in just 60 minutes.

This composite of Cotronics' unique ceramics and 316 Stainless Steel powder. Cures to provide excellent adhesion and heat resistance.

Durabond 7032 is machinable and resistant to most chemicals and solvents.

Durabond 7032 is ideal for high temperature repairs, rebuilding, filling holes, plugging leaks in automotive, maintenance and industrial applications.

One Pound Kit (7032-1)

Two Pound Kit (7032-2)

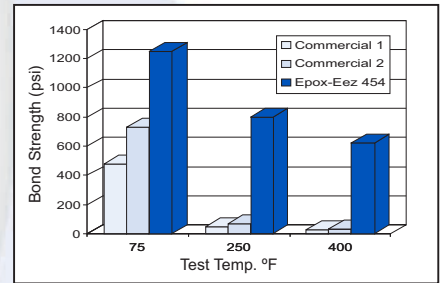

Easy to Use Dispenser Kits
Save Time



RK 454 Repairs Cast Iron Housing



7025 Repairs a Wear Plate



7032 Forms a 2000°F Seal
For an Exhaust System

High Temperature Supplies

Tapes, Hot Boards, Braze Binders

600°F - RESBOND™ 600 Tape

All Purpose Glass Silicone Tape

Just like masking tape. Bonds to all surfaces. Provides excellent abrasion, solvent and electrical resistance. Ideal for high temperature electrical insulation in motors, ovens, instruments, wiring, wire wrap, etc. Applications include sealing heat ducts and securing thermocouples, strain gauges, etc. Use as a high temperature masking tape to protect critical surfaces during welding.

600°F - RESBOND™ 620 Tape

Premium Grade Teflon Tape

Easy and convenient to use. Bonds to all surfaces with a 600°F, pressure sensitive, silicone adhesive. Resistant to abrasion, chemicals, electricity and heat. Reinforced with glass fibers for extra strength. Use for applications requiring a durable non-stick surface in the electronics, chemical, automotive and packaging industries.

600°F - RESBOND™ 640 Tape

Double Sided Tape Bonds Most Materials

Just apply to most surfaces to form a pressure sensitive adhesive bond. Use from -100°F and up to 600°F. This tape is abrasion and chemical resistant and reinforced with glass fibers for extra strength. It is handy for placement of ceramic cloths and tapes.

300°F-2000°F - RESBOND™ 650 Tape

Stainless Steel Foil Tape

Type 304 stainless steel tape bonds, aggressively, to metal and most surfaces making it ideal for thousands of applications in industry. This heavy duty self adhesive tape is supplied with a acrylic adhesive usable from -30°F to +300°F. The stainless steel can be used to 2000°F.

This tape is used wherever the corrosion, wear or strength of metallic stainless steel surface is desired.

3000°F - Thermal Boards

Braze Aids Thermal Boards are excellent high temperature work boards. They are machinable and ideal for 1000's of other uses.

They protect work tops during welding and soldering and often are used as fixturing boards for assembly applications.

Cat. No.	Dimensions	Price
Braze Aids7011	1/2" x 6' x 6'	28.95
Braze Aids7012	1/2" x 12' x 12'	38.90
Braze Aids7013	1/2" x 6' x 12'	28.75

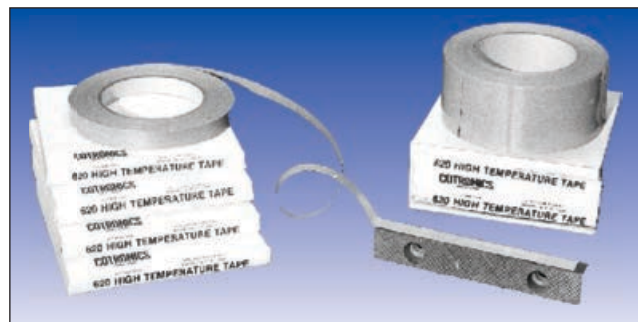

Resbond™	600	620	640	650
Base	Glass	Teflon	Silicon	304 S.S.
Cont. Use °F	600	600	500	300
Max. Temp. °F	1000	1000	600	2000
Thickness (mils.)	7	10	9	5
Adhesion (oz./in.)	36	20	20	34
Dielectric (volts/ mil)	500	600	600	N.A.

Cat. No. Width x Length

Resbond 600-1	1/2" x 100'
Resbond 600-2	1" x 100'
Resbond 600-3	2" x 100'
Resbond 620-1	1/2" x 50'
Resbond 620-2	1" x 50'
Resbond 620-3	2" x 25'
Resbond 640-1	1/2" x 50'
Resbond 640-2	1" x 50'
Resbond 640-3	2" x 50'
Resbond 650-1	1" x 9'
Resbond 650-2	3" x 9'

BRAZE AIDS™ 4B Braze Binders



Just stir in a "brazing alloy powder" to form a non-contaminating, non-setting, creamy paste that is easily applied by syringe, brush or trowel.

Braze Aids Type 4B has been used successfully with solders, brazes, hard facings, cements, etc.

Ideal for use in inert atmospheres or in vacuum brazing. No contamination, or impurities in the brazed joints.

Type 4BE is a non VOC, water based binder that is ideal for use when contamination is a concern.

Cat. No.	Description	Price
4B	Fast Drying	99.94/Quart
4BE	Water Based	99.94/Quart

RESBOND™ 907TS THREADLOCKERS

Viscosities and Strengths To Meet Your Toughest Sealant Needs

Use From -300°F to 2100°F



- **Easy to Use** No measuring. No mess. Will not run or drip while applying.
- **Economical** Just one bottle provides up to 2000 applications.
- **Room Temp. Cures** Saves time and money. No costly heat treatments.
- **High Temp. Stability** Will not soften or decompose at elevated temperatures.
- **High Bond Strength** Excellent Adhesion. Seals most metals and ceramic parts.
- **Electrical Resistance** Penetrates fine openings to provide electrical resistance.
- **Corrosion Resistance** Can be used with all conventional chemicals and solvents.

It's easy. No mixing required.

Just apply and let dry.

Resbond 907 TS cures at room temperature.

Forms thermally Stable, electrically insulating, chemically resistant bonds.

Packaged in convenient 4 oz. applicator bottles.

Will not run off or drip while applying.

Ideal for use on set screws, fasteners, bolts, pipes threads.

Removable with hand tools (under most conditions).



Resbond™ 907TS 2100°F	Use For	Viscosity (cps)	Shear Strength (psi)	Breaking Torque (inch-lbs.)	Gap Fill (in.)	Applications Include
Green Low Viscosity	Penetrates Fine Openings	2,000	370	242	0.003	Small, Set, Adjustment Screws, Fasteners and Instrumentation
Blue Standard	General Purpose	4,000	400	270	0.005	Medium Screws, Nuts, Bolts, Pipe Threads, Fittings, etc.
Red High Strength	Prevents Vibration Loosening	3,000	450	276	0.010	Large Fasteners and Set Screws. Pipe Threads, Studs, Bearings, etc.
Gold High Viscosity	Fills Large Gaps and Grooves	12,000	500	217	0.030	For difficult applications, Flanges, Bolts, Pipe Threads, Large Nuts, etc.
507TS 500°F Epoxy Teflon	General Purpose	35,000	1200	500	0.010	All purpose 2 component Epoxy Teflon for difficult applications

Cat. No.

- 907TS-1..... 4 oz. Applicator Bottles (Specify Green, Blue, Red or Gold)
- 907TSCP..... Case Pack 12 - 4 oz Applicator Bottles
- 907TS-TK..... Trial Evaluation Kit (4 - 1 oz. Applicator Bottles)
- 507TS-1..... Dispenser Kit

Description

370R CERAMIC BLANKET

REACH COMPLIANT

Highly Efficient, Thermal Insulation

- *Thermally Stable to 2730°F*
- *Flexible and Resilient*
- *Excellent Non Wetting Characteristics*



Introducing REACH compliant, high temperature, ceramic blankets, the ideal replacement for non compliant, RCF blankets.

Now Available, Cotronics' R370, ceramic blankets are made from alkaline earth silicate wool, highly efficient and ideal for use in applications that must comply with strict safety requirements and regulations.

Useable to 2370°F. They are highly efficient, thermally stable, flexible and resilient.

They have low heat storage and extremely low shrinkage.

Cotronics' REACH compliant, ceramic blankets also offer excellent resistance to chemicals and splashes of molten metal, oil and water.

(Note: not recommended for use with HF, H₃PO₄, NaOH and KOH).

APPLICATIONS

Furnace and boiler linings; chemical reactors, ovens, door seals, reusable steam and gas turbine insulation; mold wraps and investment castings, expansion joint packing, high temperature filters, fire protection, sound absorption, non-contaminating brazing and sintering separators, melting furnace back up insulation, aluminum ladle and trough covers and many more.

Cotronics R370 Blankets are available in 1/4", 1/2" 1", 1 1/2" and 2" thicknesses.

Cat. No.	Temp.	Thickness	Size/Roll
370R-2.....	2300°F.....	1/4".....	24" x 20'
370R-3.....	2300°F.....	1/2".....	24" x 12'
370R-4.....	2300°F.....	1/2".....	24" x 24'
370R-5.....	2300°F.....	1".....	24" x 12'

PROPERTIES	
Maximum Temp.	2370°F (1300°C)
Density (lbs./ft ³)	8
Composition:	
Silica (SiO ₂)	61-82%
Calcium Oxide (CaO ₂)	18-27%
Other	< 5%
Thermal Conductivity (BTU-in. / Hr. Ft ² °F)	
500°F	0.35
1000°F	0.83
1500°F	1.66
2000°F	2.77
Linear Shrinkage (%)	
24 hrs @ 2280°F	< 2
Tensile Strength (psi)	11

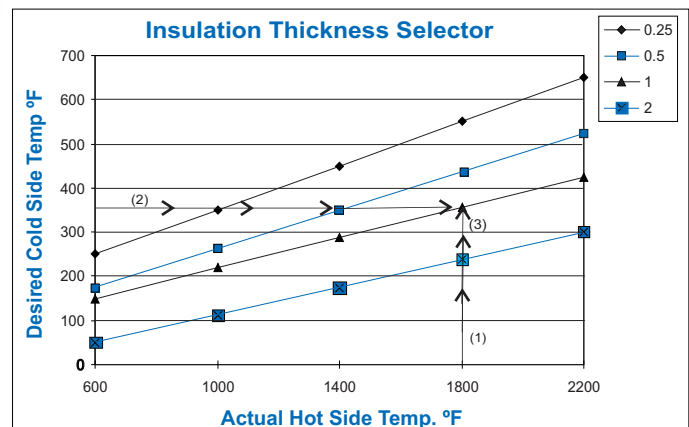

To Find your Insulation Requirements

- 1) Draw a vertical line from the hot side temperature.
- 2) Draw a horizontal line from the desired cold side temperature.
- 3) The required insulation thickness is shown at the intersection of the two lines.

Example:

For a furnace with an 1800°F working temp. and a desired outside furnace temp. of 350°F, 1" of insulation would be required

3000°F CERAMIC PAPER

High Temp, Light Weight, Flexible, Easy to Handle

Cotronics' Ceramic Papers are made from Asbestos - Free, High Purity, Alumina based refractory fibers.

Melting point is 3200°F to 3600°F.

They offer outstanding high temperature stability and can be used continuously from 2300°F to 3000°F.

Cotronics' Ceramic Paper is resistant to thermal shock and corrosion, has excellent electrical resistance, low specific heat and low thermal conductivity.

It can be cut with ordinary hand scissors, folded, wrapped, rolled and will mold around sharp corners.

Strong, free-standing shapes are easily produced.

Ideal for high temp. gaskets, combustion furnaces, induction linings, electrical insulators, handling of molten metals, brazing, heat treating and metal forming operations.

Select:

Rescor 300 General purpose needs to 2300°F.

Ultra-Temp 3300 For Extreme Temperature applications up to 3000°F.

Rescor 300BL Binderless Use in air, vacuum or atmosphere furnaces. Will not burn off organic binders. No fumes associated with initial heat up. Will not irritate users or contaminate furnaces, parts, etc.



PROPERTIES	
Melting Point (°F)	3200
Service Temp (°F)	2300-3000
Density (# / ft ³)	12
Dielectric Constant (@10 ⁸ cps)	1.61
Dielectric Strength (volts/mil.)	100
Loss Factor	0.017
Specific Heat (BTU / # °F)	0.25
Thermal Conductivity (BTU-in. /Hr. Ft ² °F)	
500°F	0.38
1000°F	0.60
1500°F	0.90
2000°F	1.33

APPLICATIONS

- Glass WorkingSmooth, will not mar glass surfaces. Cushioning, annealing, glass holders etc.
- CeramicsSupports for firing, separators, kiln construction and repair.
- Chemical.....High temp filters, construction or repair of high temperature equipment, reaction chambers lab ovens, catalytic converters.
- Electrical.....High temperature wire insulation, arc prevention, dielectric use, crystal work.
- Furnaces.....Insulation, linings, tubes, supports, trays, element holders, construction of fast heating furnaces, gaskets, induction linings, instant crucibles, thermocouples.
- High Temp.....Acoustical insulation, muffler lining, fire protection, high temperature shock absorbers, expansion joints, stress relieving, instruments, chromatography, nuclear.

Cat. No.	Temp.	Thickness	Size/Roll
300-20-3.....	2300°F.....	1/32".....	24" x 50'
300-20-2.....	2300°F.....	1/32".....	24" x 150'
300-20-1.....	2300°F.....	1/32".....	12" x 300'
300-40-3.....	2300°F.....	1/16".....	24" x 25'
300-40-2.....	2300°F.....	1/16".....	24" x 100'
300-40-1.....	2300°F.....	1/16".....	12" x 200'

Cat. No.	Temp.	Thickness	Size/Roll
300-80-3.....	2300°F.....	1/8".....	24" x 25'
300-80-2.....	2300°F.....	1/8".....	24" x 50'
300-80-1.....	2300°F.....	1/8".....	12" x 100'
UT3300-2.....	3000°F.....	1/16".....	24" x 25'
300BL-1.....	2300°F.....	1/8".....	24" x 25'
300BL-2.....	2300°F.....	1/16".....	24" x 25'
300BL-3.....	2300°F.....	1/32".....	24" x 25'

300A Ceramic Paper Trial Kit (6 ft each of Rescor 300 -1/32", 1/16", 1/8" thick and 2 ft of Rescor 300BL) 12" and 48" Widths, Custom Sizes, Quantity Prices on Request
See pages 50, 51 for Ceramic Adhesives and Hardeners

3000°F THERMAL INSULATION

Thermal Stop Insulation - Wrap-It Moldable Sheets

Thermal Stop Super Efficient 2300°F Insulation

375 Thermal Stop is high purity, aluminum oxide based, ceramic fibers uniquely bonded to a 2 mil thick layer of aluminum foil.

The ceramic fibers have a melting point of 3200°F and will provide up to 2300°F continuous service.

These resilient Ceramic Fiber Strips are used for pipe duct wrap, expansion joints, and repairs, insulation of equipment, plastic molds, pilot plant, lab units, etc.

Use Resbond 901A (page 50) for rigidizing where required.

Use band clamps or type 600 (pg 40) high temperature tape to secure pipe wraps.



Insulation Guide - 375 FT Thermal Stop Tape

Hot Surface Temp.	1000°F	1400°F	1600°F	1800°F	2200°F
375FT 1/2" thick will reduce temp to	300°F	390°F	450°F	520°F	700°F
375FT 1" thick will reduce temp to	220°F	300°F	380°F	420°F	500°F

Cat. No.	Thickness	Size/Roll	Price/Roll	Cat. No.	Thickness	Size/Roll	Price/Roll
375FT-2.....	1/2"	2" x 12'	17.95	375FT-5.....	1"	2" x 8'	19.65
375FT-3.....	1/2"	3" x 12'	25.30	375FT-6.....	1"	3" x 8'	32.45
375FT-4.....	1/2"	6" x 12'	47.20	375FT-8.....	1"	6" x 8'	52.50
375FT-1.....	1/2"	24" x 12'	164.74	375FT-7.....	1"	24" x 12'	259.95

Wrap-It Moldable Sheets

Wrap-It Moldable sheets combine Cotronics' high purity, refractory fibers with proprietary, inorganic binders in a new and economical wet felt form.

Wrap-It is cut to shape, molded and dried to form a light weight, resilient, highly efficient, thermal insulation that is also resistant to most chemicals and solvents.

Just air dry to form strong free standing shapes.

Wrap-It will not crack or flake, has excellent thermal shock resistance and is not wet by molten metals.

Wrap-It moldable sheets are ideal for molten metal handling, thermal insulation, fire proofing, burner chambers, field repair, welding supports, fixtures and molten metal dams.



Applications Include: insulation, furnace linings, mufflers, gas turbines, fans, ovens, chemical reactors, expansion joint packing, fire protection, sound absorption, stress relieving insulation, non-contaminating brazing and sintering separators. Wrap-It can be bonded with 7020 - Thermeez Ceramic Putty or 901 - Resbond Fiber Based Ceramic Adhesive (see page 51).

WRAP-IT	372	372HT	372UHT
Temp. Rating °F	2300	2700	3000
Melting Point °F	3200	3300	3600
Density (# / Ft ³)	18	18	12
Al ₂ O ₃ %	35	65	98
SiO ₂ %	65	35	2
Shrinkage (%)			
after 24 hrs. @ 1300°F	0.2	0.1	0.1
after 24 hrs. @ 2200°F	2	0.7	0.5
Thermal Cond. (BTU-in./ Hr. Ft ² °F)			
@ 1000°F	0.7	0.6	0.5
@ 1500°F	0.9	0.8	0.5

Cat. No.	Temp.	Thickness	Size/Roll
372-0.....	2300°F.....	1/8".....	2" x 12.5'
372-1.....	2300°F.....	1/4".....	2" x 12.5'
372-2.....	2300°F.....	1/2".....	2" x 12.5'
372-3.....	2300°F.....	1".....	2" x 8'
372HT-3.....	2700°F.....	1/2".....	2" x 6'
372UHT-2.....	3000°F.....	1/2".....	2" x 2'

3000°F CERAMIC BOARD

Rigid Hi-Temp. Thermal Insulation

Rescor Ceramic Board is made from Asbestos-Free, high purity, refractory fibers.

These high purity fibers have a melting point between 3200°F - 3600°F. They are thoroughly interlaced in the production process and bonded with an inorganic binder.

Now, strong, rigid, free standing shapes and parts are easily constructed. Just cut, saw or drill. Parts can be bonded together (if needed) with Resbond 901 adhesive (see page 51).

360 Ceramic Board offers excellent thermal shock resistance. It can be heated to 2000°F and cooled in minutes, without cracking.

Resistant to oxidizing and reducing atmospheres, most molten metals, steam, most chemicals and solvents. (Not recommended for use with HF, H₃PO₄ and strong Alkalies.)

Trace organic binders used in processing can be removed by a simple heat treatment, in air, at 800°F if required.

Use Rescor 360 for general purpose, 360HS for construction, 360EHS for gaskets and higher strength applications, 360H for 2700°F and 3360UHT for 3000°F applications.

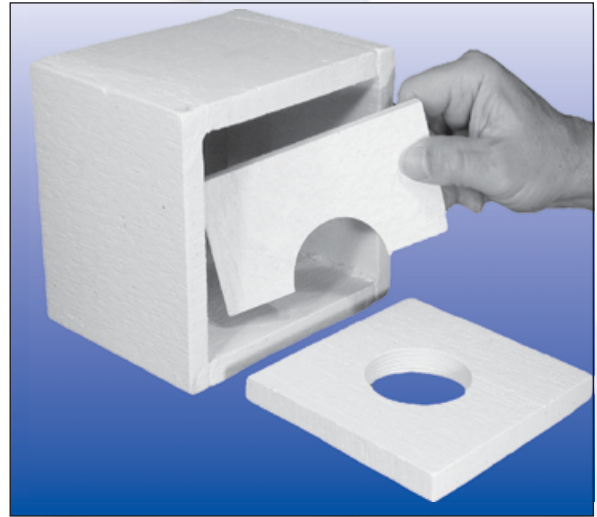

Assembling a High Temp Housing

RESCOR™ DESCRIPTION	360 General Purpose	360HS Hi-Strength Construction	360EHS Extra High Strength	360H High Temp	3360UHT Ultra Hi Temp
Continuous Use Temp (°F)	2300	2300	2300	2700	3100
Melting Point (°F)	3200	3200	3200	3300	3600
Density (#/ft ³)	16	33	60	15	15
Modules of Rupture (psi)	55	350	700	60	50
Dielectric Constant (@ 10 ⁸ cps)	1.61	1.61	1.61	1.61	1.61
Dielectric Strength (volts/mil)	100	100	100	100	100
Loss Factor	0.017	0.017	0.017	0.017	0.017
Specific Heat (BTU/# °F)	0.25	0.25	0.25	0.25	0.25
Thermal Conductivity (BTU-in./Hr. Ft ² °F)					
500°F	0.45	0.55	0.75	0.45	0.45
1000°F	0.70	0.80	0.95	0.70	0.70
1500°F	0.95	1.05	1.00	0.95	0.95
2000°F	1.55	1.75	1.95	1.55	1.55

Applications Include: High temperature free standing shapes, rigid high temp. gaskets and seals, heating element supports, heat shields, high temperature insulation and chemical reactor insulation.

Construction of laboratory, pilot plant and test systems, liquid metal handling, brazing fixture supports, Nominal thickness and sizes are shown below.

Cat. No.	Temp.	Thickness	Size	Sht/Ctn
360-1EHS.....	2300°F.....	1/8".....	12" x 24'.....	2
360-1.....	2300°F.....	1/4".....	12" x 18'.....	4
360-2.....	2300°F.....	1/2".....	18" x 24'.....	2
360-5.....	2300°F.....	1".....	18" x 24'.....	2
360-2HS.....	2300°F.....	1/2".....	18" x 24'.....	2
360-5HS.....	2300°F.....	1".....	18" x 24'.....	2
360H-5.....	2700°F.....	1/2".....	18" x 24'.....	2
3360UHT.....	3100°F.....	1/2".....	18" x 24'.....	2
7020-3.....	2300°F.....	11 oz. Caulking and Joint Sealer Putty (see page 51)		
907GF-6.....	2300°F.....	11 oz. Adhesive Putty (see page 38)		
901A.....	2300°F.....	1 Quart Surface Hardener (see page 50)		

HI-TEMP FABRICS AND TAPES

3000°F Silica Fabrics

Cotronics 399 Silica products are woven from 96% pure Silica fiber. It is totally inorganic and will not smoke when exposed to heat.

399 Silica can be used continuously at 2000°F and provides short term service to 3000°F.

399 Silica is ideal for thermal and electrical insulation, handling molten metals, hose or wire covers, gaskets, expansion joints, welding, arc and molten metal splash protection, etc.

399 Silica is available in a wide variety of forms including Sleeving, Rope, Silicone Coated or Aluminized Cloths, Curtains, Seals, Pads and Hemmed Blankets.

Quantity prices are available upon request.

Tapes

Cat. No.	Thickness	Size/Roll
399T-41.....	1".....	0.060" x 25'
399T-42.....	2".....	0.060" x 25'
399T-81.....	1".....	0.125" x 25'
399T-82.....	2".....	0.125" x 25'

Woven Fabric

Cat. No.	Thickness	Size/Roll
399C-1.....	0.030".....	36" x 10'
399C-2.....	0.054".....	36" x 10'

Adhesive Backed Pressure Sensitive Tapes

Cat. No.	Thickness	Size/Roll
399T-41PS.....	1".....	0.060" x 25'
399T-42PS.....	2".....	0.060" x 25'
399T-81PS.....	1".....	0.125" x 25'
399T-82PS.....	2".....	0.125" x 25'

Sleeving

Cat. No.	Thickness	Size
399S-1.....	1/64".....	ID x 0.008" x 25'
399S-2.....	1/32".....	ID x 0.010" x 25'
399S-7.....	1/8".....	ID x 0.035" x 25'
399S-4.....	1/4".....	ID x 0.020" x 25'
399S-5.....	1/2".....	ID x 0.035" x 25'
399S-6.....	1".....	ID x 0.035" x 25'
399S-3.....	1/16".....	

Silica Mat

Cat. No.	Thickness	Size
399M.....	1/4".....	36" x 36"



THERMEEZ™	398	399
Continuous Use Temp.	600 °F	2000 °F
Melting Point	800°F	3100°F
Silica %	0	98
Aramid %	100	0
Dielectric Constant (10 ⁸ cps)	4.00	3.80
Dielectric Strength (volts/mil.)	150	500
Thermal Conductivity (BTU in / Hr. Ft. ² °F)@500°F	0.35	0.45
Tensile Strength (psi x 10) ⁵	80	5
Modules of Elasticity (psi x 10) ⁶	12	10.50
Diameter (microns)	17	11
Porosity (%)	0	1

Braided Rope

Cat. No.	Size
399R-1.....	1/8" x 25'
399R-2.....	1/4" x 25'
399R-3A.....	1/2" x 10'
399R-3.....	1/2" x 15'
399R-4A.....	3/4" x 5'
399R-4.....	3/4" x 10'
399R-5A.....	1" x 5'
399R-5.....	1" x 10'

650°F NOMEX™ - KEVLAR™ - ARAMID FABRICS

Thermeez 398 fabrics, tapes or sleeving are woven from Nomex or Kevlar brand of Aramid Fibers. They are exceptionally strong, temp. resistant, flame retardant and will remain flexible while in use from -100°F to 650°F.

Provides short term service to 850°F.

Thermeez 398 Aramid fabrics are resistant to Fungi, Bacteria, Mildew and Abrasion. 398 is non-allergenic and lightweight.

Use for pipe wrap, heat seal covers, pressure fabrics, gaskets and packing.

Can be impregnated with epoxies or silicones for electrical applications, personal protection, flexible equipment curtains and hose coverings, etc.

Fabric

Cat. No.	Size
398C-1.....	1/8" x 40" x 24'

Sleeving

Cat. No.	Size
398T-2.....	3/8" I.D. x 100'
398T-3.....	1/2" I.D. x 100'

Tapes

Cat. No.	Size
398-41.....	1" x 1/16" x 50'
398-42.....	2" x 1/16" x 50'
398-43.....	3" x 1/16" x 50'
398-81.....	1" x 1/8" x 50'
398-82.....	2" x 1/8" x 50'
398-83.....	3" x 1/8" x 50'

Additional sizes and Pressure Sensitive Tapes Available on Request

2500°F CERAMIC TAPE

Low Cost, Stock Sizes, Ideal For 1000's of Applications

Ultra-temp Ceramic Tape is made from Asbestos Free, Aluminum Oxide based, high purity, refractory fibers.

Ultra-temp tapes can be used to temperatures exceeding 2300°F and offer outstanding high temperature stability.

They were designed to replace asbestos based products which were limited in use at 1200°F.

390 Ultra-Temp tapes can be cut with ordinary scissors and formed into complex shapes.

These tapes have low specific heat, low thermal conductivity, resistance to thermal shock, electrical insulation, good dielectric strength and excellent corrosion resistance.

Applications Include:

- **Glass Working** - Smooth will not mar glass surfaces. Use for glass cushioning, annealing, holders furnaces and furnace construction.
- **Ceramics** - Supports for firing, firing separators, kiln construction and repair.
- **Chemistry** - Filters, construction and repair of equipment, reaction construction, lab ovens, catalytic converters, fireproofing.
- **Electrical** - High temperature wire insulation, arcing prevention, dielectric use, crystal holders.
- **Furnaces** - Insulation, lining, tubes, supports, trays, element holders, construction of fast heat-up furnaces.
- **Optics** - Lamp-house insulation, holders, crystal growing equipment, crucible insulation.
- **Instruments** - Special devices, chromatography, heat sensors, thermocouple insulations, etc.
- **Welding, Brazing** - Insulation, non-stick separators.
- **Metal Working** - Liquid aluminum handling, casting alloys, instant crucibles, liners, metal molds.



**Ultra Temp 390 In Ready to Use
Job Sized Rolls**

ULTRA-TEMP™ 390	
Melting Point	3200°F
Continuous Service Temp.	2300°F
Density (# / ft ³)	12
Dielectric Constant (@ 10 ⁸ cps)	1.61
Loss Factor	0.017
Dielectric Strength (volts/mil.)	100
Specific Heat (BTU/# °F)	0.25
Thermal Conductivity (BTU-in / Hr Ft ² °F)	500°F
	1000°F
	1500°F
	2000°F

**Ultra Temp 390 is the Ideal Material
For any Shop, Laboratory, Production
or Maintenance Facility**

Cat. No.	Thickness	Size	Availability
390-21.....	1/32".....	1" x 50'.....	1-12 Rolls / 24 Rolls
390-22.....	1/32".....	2" x 50'.....	1-12 Rolls / 24 Rolls
390-23.....	1/32".....	3" x 50'.....	1-12 Rolls / 24 Rolls
390-41.....	1/16".....	1" x 50'.....	1-12 Rolls / 24 Rolls
390-42.....	1/16".....	2" x 50'.....	1-12 Rolls / 24 Rolls
390-43.....	1/16".....	3" x 50'.....	1-12 Rolls / 24 Rolls
390-81.....	1/8".....	1" x 25'.....	1-12 Rolls / 24 Rolls
390-82.....	1/8".....	2" x 25'.....	1-12 Rolls / 24 Rolls
390-83.....	1/8".....	3" x 25'.....	1-12 Rolls / 24 Rolls

Custom Sizes and Quantity Prices Available on Request
See pages 50, 51 for Ceramic Adhesives and Hardeners

2600°F ULTRA TEMP.™ TAPE AND CLOTH

Stays Flexible at Hi-Temp.

ULTRA TEMP 391 is woven from Continuous Filament, High Alumina, Ceramic Fibers.

These unique fibers weave ceramic cloths, tapes and sleeving forming materials with flexibility and strength previously unavailable.

Ultra Temp. 391 is non-hygroscopic, non-porous, abrasion resistant and dimensionally stable.

Ultra Temp. 391 is resistant to molten metal sparks and splashes, most chemicals and solvents.

Provides unexcelled chemical and electrical resistance to 2600°F continuously and to 3300°F for short periods of time.

Use Tapes, Cloths and Sleeveings for hose coverings, furnace curtains, furnace belting, metal splash curtains, glass handling, gaskets, duct joints, metal filtration, etc.

Use 391 Pressure Sensitive Adhesive Backed Tapes for aiding in the installation and placement of tapes.

Use Thread for fabricating Ultra Temp 391 and other ceramic cloths.



Tapes, Sleeveings, Cloths, Thread, etc.

Tapes

Cat. No.	Thickness	Size
391W-1A.....	0.02".....	1" x 10'
391W-1.....	0.02".....	1" x 20'
391W-2A.....	0.02".....	2" x 10'
391W-2.....	0.02".....	2" x 20'

Adhesive Backed Tapes

Cat. No.	Thickness	Size
391W-1APS.....	0.02".....	1" x 10'
391W-1PS.....	0.02".....	1" x 20'
391W-2APS.....	0.02".....	2" x 10'
391W-2PS.....	0.02".....	2" x 20'

Cloth

Cat. No.	Thickness	Size
391C-1.....	0.060".....	12" x 5'
391C-1A.....	0.060".....	12" x 2'
391C-2.....	0.060".....	12" x 10'
391C-3.....	0.030".....	30" x 25'

Thread

Cat. No.	Size
391T-10.....	0.020" Dia. x 250'
391T-11.....	0.020" Dia. x 500'

Lacing (Rope)

Cat. No.	Size
391T12.....	0.060" Dia. x 50'

391 ULTRA-TEMP	
Continuous Use Temp. °F	2600
Melting Point °F	3300
Dielectric Constant (10 ⁸ cps)	1.61
Dielectric Strength (volts/mil.)	500
Thermal Conductivity (BTU in / Hr. Ft ² °F)	
500°F	0.45
1000°F	0.90
2000°F	1.60
BASE FIBER:	
Alumina & Refractory Oxides (%)	98
Tensile Strength (psi)	250,000
Modules of Elasticity (psi)	22 x 10 ⁶
Diameter (microns)	11
Porosity (%)	0

Sleeving

Cat. No.	ID	Wall Thickness	Length
391T-0.....	1/16".....	1/32".....	25'
391T-1.....	1/8".....	1/32".....	25'
391T-2.....	1/4".....	1/32".....	15'
391T-3.....	1/2".....	1/32".....	10'
391T-5A.....	1".....	1/32".....	5'
391T-5.....	1".....	1/32".....	10'
391T-6.....	1.5".....	1/32".....	5'
391T-7.....	2".....	1/32".....	5

Sleeving is available to 3.5"

Quantity Prices Available on Request'

THERMEEZ™ CERAMIC TAPES, SLEEVING AND CLOTHS

Strong and Durable - Use to 1500°F

Thermeez Fabrics are woven from industrial grade, Asbestos Free, ceramic fibers.

Thermeez 395 is usable up to 1100°F and Thermeez 397 is usable up to 1500°F.

Thermeez Fabrics are high strength, flexible, durable, dimensionally and chemically stable and have excellent electrical resistance.

They are Resistant to molten metal sparks and splashes, most chemicals and solvents.

Thermeez Products are user friendly and unlike fiberglass, non-irritating to the skin. They are non-toxic, meet OSHA requirements and will not burn.

Thermeez Woven Ceramic Fiber Products are ideal for thermal insulators, padding, gaskets, flexible curtains, liquid metal

Use Woven Tapes for pipes, hoses, cables, exhaust systems, equipment wrapping, door gaskets, strip curtains etc.

Use Adhesive Backed Pressure Sensitive Tapes to simplify wrapping Thermeez tapes around complex objects for fast and economical insulation of pipes, cables etc. This adhesive allows for insulation and personal protection of tongs, forceps, hot working tools, glass handling equipment, etc.

Use Woven Cloths for furnaces, fire and splash curtains, fabrication of insulation blankets, pillows, protective clothing, etc.

Use Sleeving for hi-temp. tubing, hose and wire insulation, protection, resilient gasketing, etc. Select the I.D. required to slide over tubes, hoses, cables etc.

Use Rope for gaskets, packing, seals, doors, access ports

WOVEN TAPES

Cat. No.	395	397
Dimensions	Max Temp.	
1/32" x 1" x 100'1100°F1500°F
1100°F1500°F
1100°F1500°F
1/16" x 1" x 100'1100°F1500°F
1100°F1500°F
1100°F1500°F
1/8" x 1" x 100'1100°F1500°F
1100°F1500°F
1100°F1500°F
1/4" x 1" x 50'1100°F1500°F
1100°F1500°F
1100°F1500°F



ADHESIVE BACKED TAPES

Cat. No.	395PS	397PS
Dimensions	Max Temp.	
1/32" x 1" x 50'1100°F1500°F
1100°F1500°F
1100°F1500°F
1/16" x 1" x 50'1100°F1500°F
1100°F1500°F
1100°F1500°F
1/8" x 1" x 50'1100°F1500°F
1100°F1500°F
1100°F1500°F



WOVEN CLOTH

Cat. No.	395C	397C
Dimensions	Max Temp.	
1/16" x 6" x 25'1100°F1500°F
1/16" x 40" x 5'1100°F1500°F
1100°F1500°F
1100°F1500°F



Thermeez™	395	397
Melting Point	2800°F	2800°F
Max. Continuous Service	1100°F	1500°F
Density (# / ft ³)	30	35
Specific Heat (BTU / #°F)	0.25	0.25
Dielectric Strength (volts/mil.)	450	450
Thermal Conductivity (BTU in / Hr. Ft ²)		
@ 500°F	0.48	0.50
@ 1000°F	0.90	0.95

WOVEN SLEEVING

Cat. No.	395T	397T
I.D. X Length.	Max Temp.	
1/8" x 100'1100°F1500°F
1/4" x 100'1100°F1500°F
3/8" x 100'1100°F1500°F
1/2" x 100'1100°F1500°F
3/4" x 100'1100°F1500°F
1" x 100'1100°F1500°F
1.5" x 50'1100°F1500°F
2" x 50'1100°F1500°F



Note: wall thickness is 1/16"

When ordering specify Thermeez 395 for 1100°F service

Thermeez 397 for 1500°F service

907GF Adhesive/Putty is ideal for bonding Thermeez Insulation Materials (page 38)Gaulk

Quantity Prices and Custom Sizes on Request

HARDENERS AND ROPES

901A Liquid Insulation Hardener and Ridgidizer

Rescor 901A Ceramic Hardener is a clear liquid which penetrates into the surface of porous ceramics to form a strong ceramic bond and harden the surface.

No organics. No solvents.

Just brush on and let dry.

Use 901A to prime surfaces before bonding and extend the life and wear resistance of insulation materials.

Can be applied directly to transite, marinate, calcium silicate, rock wool, mineral wool and ceramic fiber insulation.

Hardens and extends the life and wear resistance of all porous ceramics.

Melting point is 3200°F.

Density is 10 pounds/gallon.

Clean tools or containers with water.



Cat. No.	Temp.	Size
901A-1.....	2300°F.....	Quart
901A-2.....	2300°F.....	Gallon
901A-3.....	2300°F.....	5 Gallons

ULTRA TEMP.™ Insulating and Gasketing Ropes

395R - 1100°F Braided Rope

Thermeez 395R is made from Industrial Grade, Asbestos Free, Ceramic Fibers.

These fibers are high in strength, flexible, durable, dimensionally and chemically stable and provide excellent electrical resistance.

They are user friendly and, unlike fiberglass, are non-irritating to the skin.

They are non-toxic, will not burn and meet OSHA requirements.

Ideal for gaskets, packing, seals, doors, padding, access ports, fabricating tadpole gaskets, etc.

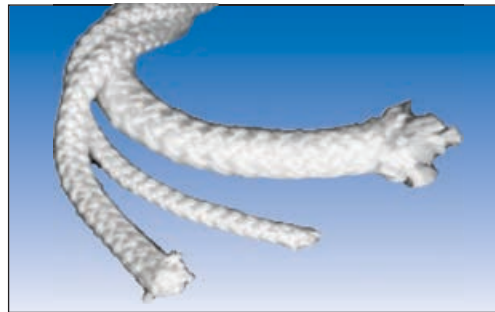

Thermeez 395R Braided Rope

396HT - 2300°F Ultra Temp. Rope

Thermeez 396HT is made from high purity, asbestos free, refractory fibers that have a melting point of 3200°F.

Ultra-Temp 396HT Rope offers high mechanical strength, excellent thermal insulation, low heat storage, high electrical and thermal shock resistance, good dielectric strength and excellent corrosion resistance.

Designed to replace asbestos based products which are limited in use to 1200°F.

Cotronics' Ultra-Temp Rope can be used to temperatures exceeding 2300°F.

Used for forming gaskets, sealing, packing, glass working, furnace support, induction heating, expansion joints.



Thermeez 396HT Ultra Temp. Rope

Cat. No.	Temp.	Dia.	Length
396R-1.....	1100°F.....	3/8".....	100'
396R-2.....	1100°F.....	1/2".....	100'
396R-3.....	1100°F.....	1".....	50'
396R-4.....	1100°F.....	1/4".....	100'
396R-4A.....	1100°F.....	1/4".....	50'
396HT-1.....	2300°F.....	3/8".....	50'
396HT-2.....	2300°F.....	1/2".....	50'
396HT-3.....	2300°F.....	1".....	25'
396HT-4.....	2300°F.....	1/4".....	50'
396HT-4A.....	2300°F.....	1/4".....	25'

PRODUCT	395R	396HT
Melting Point	2800°F	3200°F
Continuous Service Temp. (°F)	1100	2300
Density (#/ft ³)	30	30
Specific Heat (BTU/#°F)	0.25	0.25
Dielectric Constant (@ 10 ⁸ cps)	1.61	1.61
Loss Factor	0.017	0.017
Dielectric Strength (volts/mil.)	450	100
Thermal Cond. (BTU in/Hr. F ² °F) @ 500°F	0.48	0.60
Breaking Strength # (3/8" dia.)	500	150

CERAMIC ADHESIVES AND PUTTY

Room Temp. Cure, Use to 3000°F

2300°F - Ceramic Putty Cures at Room Temperature

Thermeez 7020 Ceramic Putty is made from high purity, Aluminum Oxide based, ceramics that have a melting point in excess of 3200°F.

Thermeez Ceramic Putty is formulated with special ceramic binders that upon drying produce a strong ceramic body. It is the equivalent of Plastic Wood.

Just apply and let dry. Cures in 24 hours at room temperature. Resistant to molten metals, most chemicals, oxidizing and reducing atmospheres.

Use for instant repairs to brick, burner blocks, insulation, furnaces holders, thermocouples, etc.

Applications include molding and bonding ceramic fiber components, high temperature insulation, insulation of pipes, supports, burners, turbines, etc.

Repair of cracked or damaged ceramic insulation, liquid metal handling components, brazing fixtures and supports, thermocouples insulation, etc.



Cat. No.	Temp.	Size
Thermeez 7020-5.....	2300°F.....	3 - 4 oz Tubes
Thermeez 7020-3.....	2300°F.....	11 oz. Cartridge
Thermeez 7020-6.....	2300°F.....	1 Gallon Pail

2300°F - RESCOR™ 901 Adhesive and Protective Coating

Bonds, Laminates, Molds and Rigidizes

Rescor 901 Ceramic Fiber Adhesive and Coating is a high purity, Alumina Oxide based, Ceramic Composite that combines the refractory properties of Alumina with ceramic fiber reinforcement.

No organics. No solvents. No VOC's. No out gassing.

Provides excellent resistance to oxidizing and reducing atmospheres, molten non-ferrous metals, steam, most chemicals and solvents.

Packaged in a ready to use, rich, creamy paint form. Just remix and apply.

It is easily applied by brushing, spraying or dipping and cures at room temperature to form a hard surface coating.

Use as an adhesive for bonding porous ceramics, as a coating for flame, oxidation, corrosion and erosion resistance and as a chemical barrier against diffusion and wetting in high temperature processing.

Cat. No.	Temp.	Size
Rescor 901-1.....	2300°F.....	Quart
Rescor 901-2.....	2300°F.....	Gallon
Rescor 3901-1.....	3000°F.....	Quart

Rescor / Thermeez Cat No.	FIBER ADHESIVE 901	CERAMIC PUTTY 7020
Appearance	White Paste	White Putty
Density (#/ft ³)	120	40
Melting Point (°F)	3200	3200
Continuous Use Temp. (°F)	3000	3000
Compressive Strength (psi)	1200	1500
Specific Heat (BTU / # °F)	0.25	0.25
Thermal Cond. (@ 500°F) (BTU in. /Hr. Ft ² °F)	2.00	0.65
Dielectric Strength (volt/mil)	200	100
Dielectric Constant (@10 ⁸ cps)	1.61	1.61
Loss Factor	0.017	0.017



COTRONICS' MACHINABLE CERAMICS

Low Cost and Usable to 3000°F

Now Researchers, Engineers and Designers can produce a host of new ceramic parts using a completely in house process.

Rescor Ceramics are easy to machine with conventional shop equipment and standard cutting tools.

They can be turned, drilled, tapped, milled, sawed and even ground.

No more costly, time consuming processes. No more delays. No problems with part revisions or modifications.

Rescor Ceramics are the ideal replacement for custom made ceramics.

They offer high temperature stability, excellent electrical characteristics, corrosion, abrasion and chemical resistance.

They can be used up to 3000°F in all oxidizing, reducing or vacuum atmospheres.

Select from Alumina Silicate, Non porous glass-ceramic, Macor™, 96% Alumina, High Strength-Non Porous Alumina, Silica, Graphite and Boron Nitride (on request).

Cotronics' Rescor Machinable Ceramics are readily available in a wide range of rods and plates, in stock ready for shipment. Detailed machining instructions are included.



Cat. No.	902	914	915	916	960	961	310M	311	56L
Material	Alumina Silicate	Glass Based	MACOR™	Boron Nitride	Alumina 96%	Alumina 98%	Silica	Alumina Silica	Graphite
Maximum Temp	2100°F	1000°F	1800°F	1500°F	3000°F	3100°F	3000°F	2600°F	5400°F
Compressive Strength (psi)	38,000	40,000	50,000	30,000	60,000	380,000	1,200	500	16,000
Flexural Strength (psi)	14,000	26,000	15,000	10,000	38,000	40,500	520	250	6,500
Thermal Expansion (x 10⁻⁶ / °F)	1.80	5.20	5.20	5.24	4.30	3.70	0.30	2.90	3.10
Thermal Conductivity (BTU in/Hr. Ft²°F)	9	2.8	12	12	32	42	1.3	2.4	50+
Volume Resistivity (ohm-cm)	10 ¹⁴	10 ¹⁴	10 ¹⁴	10 ¹³	10 ¹⁴	10 ¹⁵	10 ⁹	10 ⁸	N/A
Dielectric Strength (volts/mil)	100	480	1000	1000	200	500	100	100	N/A
Loss Factor (@ 1 Mhz)	0.04	0.01	0.003	0.0008	0.0016	0.001	0.0002	0.02	N/A
Dielectric Constant (@ 1 Mhz)	5.30	7.50	6.00	4.40	9	9	3.17	2.17	N/A
Porosity (%)	2.90	0	0	2.00	10	0	63	52	10
Density (gm/cc)	2.30	2.60	2.52	2.00	3.0	3.82	0.80	0.80	1.63
Hardness (Mohs scale)	6	5	5	2	5	8	4	4	3
Adhesive for Bonding	919	940	940	908	989	989	940LE	940LE	931
Machining Instructions (pg. no.)	10	12	12	12	12	12	12	12	12

Send in your Prints
for Custom Machining Services

902 MACHINABLE ALUMINA SILICATE

Super Machinability - Versatile - Low Cost

Rescor 902 Machinable Ceramic is a high purity, high temp. ceramic with excellent electrical and mechanical properties.

No more long lead times for custom made parts.

902 is a fine grained ceramic that is readily machinable on conventional shop equipment with standard cutting tools.

Can be turned, drilled, shaped, etc. to produce sharp, detailed parts with close tolerances.

Provides excellent electronic, mechanical and thermal properties. It is inert to oxidizing and reducing atmospheres, resistant to most acids, chemicals, solvents and has excellent thermal shock resistance.

Does not contain organics to out-gas or contaminate critical vacuum or furnace atmospheres.

Rescor 902 is usable as supplied to 1100°F.

A simple heat treatment, after machining, at 1900°F, hardens and extends the temperature capability up to 2100°F.

Use 902 Alumina Silicate for rapid prototypes, fabrication of electrical insulators, furnace components, brazing, soldering, welding fixtures, thick and thin film applications, R. F. heating fixtures, prototype ceramic components, etc.

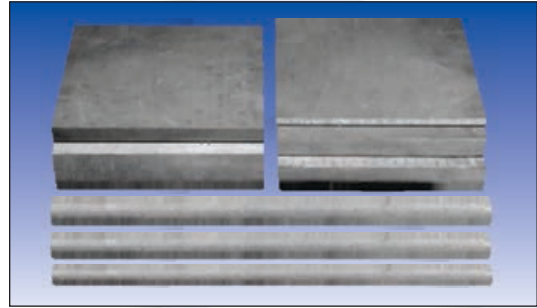

Stock Sizes Available For Fast Deliveries



Easily Machined to Highly Detailed Parts

Precision Components - Tooling - Fixturing

Melting point (°F)	3200	Dielectric Strength (volts/mil)	100
Continuous Service Temp. (°F)	2100	Volume Resistivity (ohm-cm)	10 ¹⁴
Compression Strength (psi)	38,000	Loss Factor(@ 1 Mhz)	0.04
Flexural Strength (psi)	14,000	Dielectric Constant (@ 1 Mhz)	5.30
Thermal Expansion (x 10 ⁻⁶ / °F)	1.80	Density (#/Ft ³)	145
Thermal Conductivity (BTU in / Hr. °F ft. ²)	9	Typical Tolerances	-0.005" - 0.030"
		Properties are shown for Heat Treated 902	

Cat. No.	Plates Stock Sizes
902-1.....	1/4" x 6" x 6"
902-1A.....	1/4" x 4" x 9.5"
902-3.....	1/2" x 4" x 9.5"
902-4.....	1/2" x 6" x 6"
902-6.....	3/4" x 4" x 9.5"
902-7.....	3/4" x 6" x 6"
902-9.....	1" x 4" x 9.5"
902-10.....	1" x 6" x 6"
902-12.....	2" x 4" x 9.5"
902-13.....	2" x 6" x 6"
902-22.....	1.5" x 6" x 6"
902-23.....	1.5" x 4" x 9.5"
902-25.....	1/4" x 9.5" x 9.5"
902-26.....	1/2" x 9.5" x 9.5"
902-27.....	1" x 9.5" x 9.5"

Cat. No.	Plates Stock Sizes
902-14.....	1/4" x 9.5"
902-15.....	1/2" x 9.5"
902-16.....	3/4" x 9.5"
902-17.....	21" x 9.5"
902-18.....	1.5" x 9.5"
902-19.....	2" x 9.5"
902-19A.....	2.5" x 9.5"
902-20.....	3" x 9.5"
902-50.....	3.5" x 9.5"
902-24.....	4 x 9.5"
902-Kit.....	Trial Kit

**Send in your Prints
for Custom Machining Services**

HIGH TEMP CERAMICS

3100°F High Strength 99.8% Alumina

Rescor 961 is a high strength, zero porosity, fully fired, 99.8% Alumina Ceramic that can be used continuously to 3100°F.

This grade of Alumina is extremely wear resistant and can be machined only with special tooling.

No additional heat treatment is required.

Rescor 961 has the chemical, thermal and electrical resistance required for applications in the electrical, electronic, metallurgical, fixture and vacuum industries.

Now available in economical stock sizes for every application.

Rescor 961 can be bonded with Resbond 989 (page 27) or 903HP (page 26).



RODS - BARS - TUBES

Rods

Cat. No.	Dia. x Length
961-10.....	1/8" x 12"
961-11.....	1/4" x 12"
961-12.....	5/16" x 12"
961-13.....	3/8" x 12"
961-14.....	1/2" x 12"
961-9.....	3/4" x 12"

Bars

Cat. No.	OD x ID x Length
961-15.....	1/8" x 1/8" x 12"
961-16.....	1/4" x 1/4" x 12"

Tubes

Cat. No.	OD x ID x Length
961-1.....	1/8" x 1/16" x 12"
961-2.....	3/16" x 1/8" x 12"
961-3.....	1/4" x 1/8" x 12"
961-4.....	1/2" x 3/8" x 12"
961-5.....	3/4" x 1/2" x 12"

Two Hole Tubes

Cat. No.	OD x ID x ID x Length
961-6.....	0.125" x 0.040" x 0.040" x 18"
961-7.....	0.188" x 0.063" x 0.063" x 18"

Squares

Cat. No.	Thickness x Width x Length
961-20.....	.025" x 4.5" x 4.5"
961-22.....	.040" x 4.5" x 4.5"
961-21.....	.060" x 4.5" x 4.5"

Discs

Cat. No.	Thickness x Dia.
961-17.....	0.094" x 2"
961-18.....	0.156" x 4"
961-19.....	0.188" x 6"

Bolts - Nuts (Sets contain 1 Bolt, 1 Nut and 1 Washer)

Cat. No.	Dia. x Length
961-30.....	8/32" x 1.5"
961-31.....	1/4"-20 x 1.5"
961-32.....	1/4"-20 x 3.0"

Rescor™ Cat No.	Al ₂ O ₃ 961	Glass 962
Max Service Temp. (°F)	3100	500
Density (gm/cc)	3.82	2.23
Thermal Cond. (BTU in / Hr. Ft ² °F)	42	8
Thermal Expansion (x 10 ⁻⁶ /°F)	3.70	1.80
Compressive Strength (psi)	380,000	N/A
Flexural Strength (psi)	40,500	6,900
Modules of Elasticity (x 10 ⁶)	50	64
Dielectric Strength (volts/mil)	500	100
Volume Resistivity (ohm/cm)	10 ¹⁵	10 ⁸
Porosity (%)	0.00	0.00

RESCOR™ 962 Borosilicate Glass

Rescor 962 is a high strength, zero porosity, Borosilicate Glass. It is extremely resistant to most chemicals and solvents, can be machined with glass-cutting tools and used continuously to 450°F.

It is clear and transparent, making it ideal for use in many applications.

Rescor 962 is now available in economical stock sizes.

Custom parts and sizes on request.

Rescor 962 is easily bonded with Duralco 4463 (page 15) or Resbond 940LE (page 31).

Rods

Cat. No.	Dia. x Length
962-10.....	0.157" x 12"
962-11.....	0.236" x 12"
962-12.....	0.321" x 12"
962-13.....	0.50" x 12"

Tubes

Cat. No.	OD x ID x Length
962-1.....	0.25" x 0.16" x 12"
962-2.....	0.50" x 0.31" x 12"
962-3.....	0.75" x 0.50" x 12"

Squares

Cat. No.	Thickness x Width x Length
962-20.....	0.12" x 4.0" x 4.0"
962-22.....	0.25" x 4.0" x 4.0"
962-21.....	0.37" x 4.0" x 4.0"

Discs

Cat. No.	Thickness x Dia.
962-17.....	0.25" x 2"
962-18.....	0.25" x 4"
962-19.....	0.25" x 6"

Quantity Prices on Request

960 MACHINABLE ALUMINA

Ultra High Temp. Use Up To 3000°F

- **Electrical Components**
- **Insulators**
- **Prototypes**
- **Brazing, Vacuum
& R. F. Heating Fixtures**



Precision Components - Tooling - Fixturing

Rescor 960 is a 96% Alumina, Machinable Ceramic that is usable to 3000°F.

It is manufactured from high purity alumina by a unique process.

Machining can be accomplished with conventional tooling on standard shop equipment. No heat treatment is required.

Rescor 960 Machinable Alumina can be used continuously to temperatures of 3000°F and offers the convenience and economy of an in house capability for Alumina parts.

The chemical, thermal and electrical properties of Rescor 960 is equivalent to standard high alumina ceramics.

Rescor 960 is ideal for applications in electrical, electronic, metallurgical, fixtures and vacuum industries.

Use Rescor 960 hardener (a clear ceramic impregnant) to harden and increase the wear resistance of the 960 surface. Just apply and cure at 600°F.

Rescor 961 is a fully dense, zero porosity, high strength

Physical Properties	
Max Operating Temp (°F)	3000
Melting Point (°F)	3400
Compressive Strength (psi)	60,000
Flexural Strength (psi)	38,000
Thermal Expansion ($\times 10^{-6}/^{\circ}\text{F}$)	4.30
Density (gm/cc)	3.00
Dielectric Strength (volts/mil)	200
Volume Resistivity (ohm-cm)	10^{14}
Loss Factor (@ 1MHz)	0.0016
Dielectric Constant (@ 1MHz)	9
Thermal Cond. (BTU in / Hr. Ft ² °F)	32
Typical Tolerances	-0.005" to +0.030"

Cat. No.	Rod Stock Sizes
960-1.....	1/4" x 6"
960-3.....	1/2" x 12"
960-4.....	5/8" x 12"
960-5.....	3/4" x 12"
960-7.....	1" x 12"
960-12.....	1.5" x 12"
960-9.....	2" x 12"
960-10.....	2.5" x 12"
960-11.....	3" x 12"
960-13A.....	3.5" x 6"
960-13.....	3.5" x 12"

Cat. No.	Plate Stock Sizes
960-14.....	1/4" x 6" x 6"
960-15.....	1/2" x 6" x 6"
960-16.....	3/4" x 6" x 6"
960-17.....	5/8" x 6" x 6"
960TK.....	Trial Kit
960H.....	Hardener Pint

**Send in your Prints
for Custom Machining Services**

HIGH TEMPERATURE CERAMICS

1800°F MACOR™ Glass Ceramic

A dense, vacuum tight, glass ceramic composite that is readily machinable and usable to 1800 °F.
 Can be ground, sawed, turned, tapped, milled, drilled, etc. Will provide dense "0" porosity parts in house.
 Has excellent electronic properties even at high frequencies.
 Use in critical medical and high vacuum applications.
 In stock for quick deliveries.
 Full machining instructions are included. No post machining heat treatments required.
 MACOR is a registered trade mark of Corning Glass.

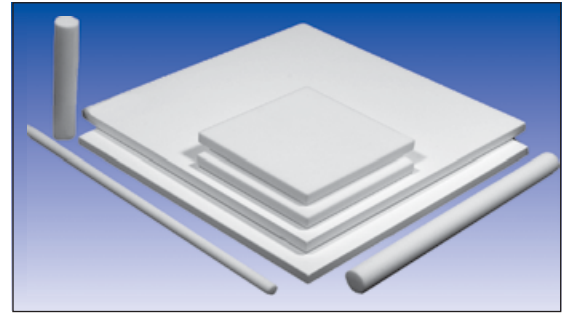

Rescor™ 915 Plates and Rods

Cat. No.	Plate Stock Sizes
915-1.....	1/4" x 3" x 3"
915-2.....	1/4" x 6" x 6"
915-3.....	1/2" x 3" x 3"
915-4.....	1/2" x 6" x 6"
915-5.....	3/4" x 3" x 3"
915-6.....	3/4" x 6" x 6"
915-7.....	1" x 3" x 3"
915-8.....	1" x 6" x 6"
915-17.....	1" x 1" x 3"
915-16.....	2" x 2" x 3"
915-9.....	1/4" x 12"
915-10.....	1/2" x 6"
915-11.....	1/2" x 12"
915-11A.....	3/4" x 12"
915-12.....	1" x 6"
915-13.....	1" x 12"
915-18.....	2" x 3"
915-TK.....	TRIAL KIT

Rescor Base	915 Macor™	56L Graphite
Max Service Temp.	1800°F	3000°C
Density (gm/ cc)	2.52	Inert atm. 1.63
Thermal Cond. (BTU in / Hr. Ft ² °F)	12	50+
Thermal Expansion (x 10 ⁻⁶ / °F)	5.20	3.10
Compressive Strength (psi)	50,000	16,000
Flexural Strength (psi)	15,000	6,500
Modules of Elasticity (x 10 ⁶)	9.30	1.60
Dielectric Strength (volts/mil)	1000	N/A
Volume Resistivity (ohm - cm)	10 ¹⁴	N/A

3000°C Ultra Grade Graphite

Rescor L56 Graphite is a fine grain Graphite.
 It is easily machined to close tolerances and will not warp, shrink or crack due to thermal stress. Will not wet by glass or metal oxides.
 Rescor L56 has high strength and its unique grain structure make it ideal for all purposes.
 Can be used to 600°F - 800°F in air atmospheres and up to 3000°C in inert atmospheres.
 Ideal for semi conductors, boats, fixtures, hot pressing dies, glass to metal, seals, heating elements, crucibles, casting precious metals, forming and handling glass, etc.
 Custom sizes and quantity prices are available upon request. See page 32 for Resbond 931 Graphite Adhesive.
 Typical tolerances are +/- 0.020".

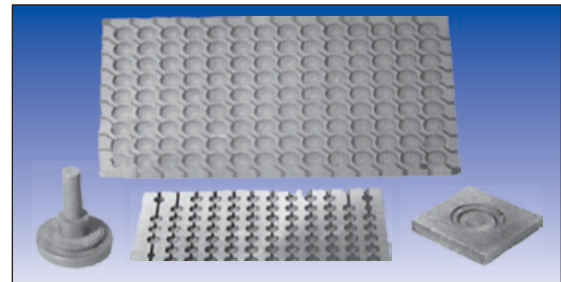

Rescor™ 56L Graphite Precision Fixtures

New 931S is a clear liquid which penetrates Graphite surfaces, improving both the wear and oxidation resistance (see page 32 for details).

Cat. No.	Stock Sizes
56L-1.....	1/4" x 6" x 6"
56L-2.....	1/2" x 6" x 6"
56L-3.....	1" x 6" x 6"
56L-4.....	1" x 12" x 12"

Cat. No.	Rod Stock Sizes
56L-5.....	1/4" x 12"
56L-6.....	1/2" x 12"
56L-7.....	1" x 12"
56L-8.....	2" x 12"
Resbond 931S-1.....	Sealer (Pint)

914 MACHINABLE GLASS CERAMICS

Vacuum Tight, High Resistance and Impact Strength

Precision Components Tooling - Fixturing

- **Electrical Components**
- **Insulators**
- **R. F. Heating Fixtures**
- **Supports**
- **Brazing**
- **Soldering Fixtures**
- **Vacuum Components**
- **Prototype Hardware**

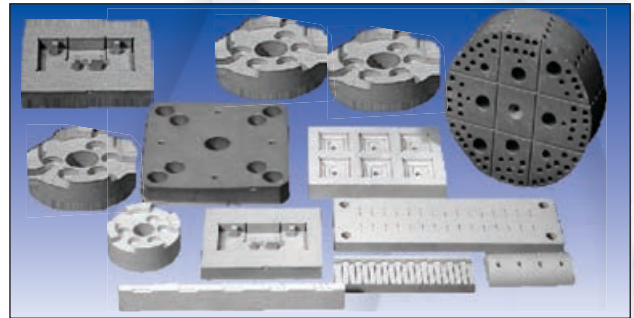
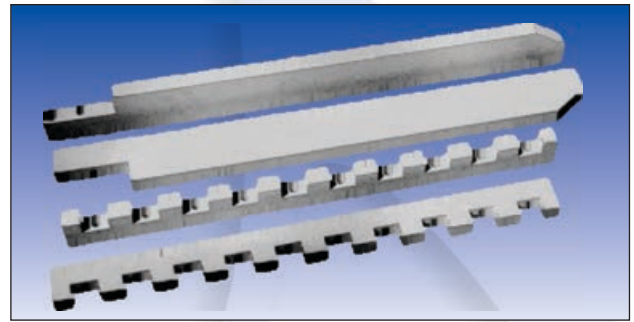

A dense and vacuum tight, Glass Ceramic Composite that is readily machinable on conventional equipment with standard cutting tools.

No post machining heat treatments are required.

Rescor 914 Glass Ceramic is inert to oxidizing and reducing atmospheres and usable to 1000°F maximum. Offers excellent mechanical and electrical properties and has a dielectric strength of 480 volts/mil.

Can be metallized and soldered.

Rescor 914's low thermal conductivity, high impact and mechanical strength make it an ideal high temp material.

Ideal for vacuum feed-throughs and for all electrical and vacuum needs.

Rescor 914 is low in cost and can be used instead of Macor™ (glass ceramic) if temperatures do not exceed 1000°F.

Full machining instructions included.

New, high temperature grade, Rescor 914HT will provide service to 1100°F and is available upon request.

Rescor™ Base	914 Glass Ceramic
Max Service Temp. (°F)	1000
Continuous use Temp. (°F)	800
Density (gm/ cc)	2.60
Thermal Cond. (BTU in / Hr. Ft² °F)	2.80
Thermal Expansion (x 10 ⁻⁶ / °F)	5.20
Compressive Strength (psi)	40,000
Flexural Strength (psi)	26,000
Dielectric Strength (volts / mil)	480
Volume Resistivity (ohm - cm)	10 ¹⁴
Loss Factor (@ 1 Mhz)	0.01
Dielectric Constant (@ 1 Mhz)	7.50
Typical Tolerances Plates (in.)	+/- 0.015
Typical Tolerances Rod (in.)	+/-0.005

Cat. No.	Stock Sizes
914-1.....	1/16" x 12" x 18"
914-4.....	1/8" x 9" x 12"
914-5.....	1/8" x 12" x 18"
914-9.....	1/4" x 9" x 12"
914-10.....	1/4" x 12" x 18"
914-15A.....	1/2" x 9" x 12"
914-15.....	1/2" x 12" x 18"
914-17A.....	3/4" x 9" x 12"
914-17.....	3/4" x 12" x 18"

Cat. No.	Stock Sizes
914-19A.....	1" x 9" x 12"
914-19.....	1" x 12" x 18"
914-22.....	1/4" x 12" rod
914-25.....	1/2" x 12" rod
914-28.....	3/4" x 12" rod
914-31.....	1" x 12" rod
914-32.....	1-1/4" x 12" rod
914-TK.....	Trial Kit

Send Prints For Custom Machining Services

3000°F CERAMIC FOAM

Machinable & Insulating Ceramic Blocks

310M Machinable Ceramic Blocks

Rescor 310 Foam is composed of over 99% pure fused Silica Ceramic and withstands temperatures to 3000°F.

310 Ceramic Foam features low thermal expansion, high thermal shock resistance, low thermal conductivity and high thermal reflectance.

It is resistant to oxidizing and reducing atmospheres, molten metals, steam, corrosive gases, most acids, chemicals and solvents.

Does not contain organics and will not out-gas in vacuum atmospheres.

White Hot, 2000°F, Ceramic Foam parts can be immersed in water without cracking.

Rescor 310 is easily cut, sawed and drilled.

Can produce highly detailed parts with unique properties suitable for many applications.

Applications include Miniature heater forms, heat reflectors, instrumentation parts and assemblies, radiant heater panels, severe thermal shock applications, etc.

Typical Tolerances are -0.015" to +0.060".

Cat. No.	Size
310M-1.....	4.5" x 6" x 9"
310M-2.....	4.5" x 9" x 12"
310M-3.....	4.5" x 12" x 18"
310-4.....	Trial Kit (Misc. Pieces)
901A-1.....	Hardener (Quart)



Rescor 310 Heating Element Reflectors

Rescor™	310M	311
TYPE	High Strength	Insulating
GRADE	Machinable	Blocks
Max Service Temp. °F	3000	2600
Density (# / ft ³)	50	50
Porosity %	63	52
Thermal Expansion (x10 ⁻⁶ /°F)	0.30	2.90
Thermal Cond. (BTU in / Hr. Ft ² °F)	1.30	2.40
Compressive Strength (psi)	1200	500
Flexural Strength (psi)	520	250
Dielectric Constant (@ 1 MHz)	3.17	2.17
Loss Factor (@ 1 MHz)	0.0002	0.02
Resistivity (ohm/cm)	10 ⁹	10 ⁸

311 Ceramic Blocks

Economical Rescor 311 Foam is composed of Alumina Silica Ceramic and withstands temperatures to 3000°F.

Low Cost 311 Ceramic Foam is used for applications where the strength and fine grain structure of Rescor 310 foam is not required.

It is resistant to oxidizing and reducing atmospheres, molten metals, steam, corrosive gases, most acids, chemicals and solvents.

No organics. Will not out-gas in vacuum atmospheres.

Rescor 311 is easily cut, sawed and drilled.

Larger shapes are easily produced.

Just prime the surfaces with the 901A liquid hardener (pg 50) and join surfaces with 901 adhesive (pg 51) or seal joints with 7020 Ceramic Putty (pg 51).

These assemblies can then be machined to the final sizes and shapes.

Surfaces are rough with some porosity. Sizes are nominal.

Also available, Rescor 740, a unique castable ceramic foam, great for fabricating very large or irregular shapes (page 59)

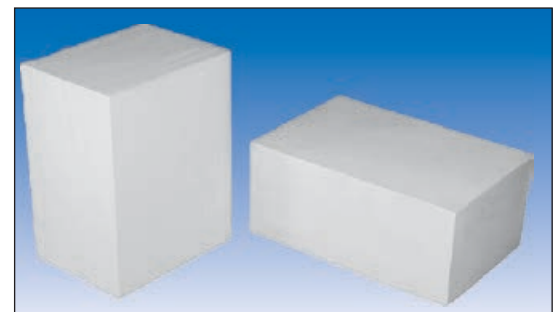

Rescor 311 Ceramic Foam Blocks

Cat. No.	Size
311-1.....	2.5" x 4.5" x 9"
311-2.....	2 pack
311-3.....	4 pack

2300°F Ceramic Putty Ideal for Sealing Joints (See page 51)

Cat. No.	Size
7020-5.....	3 - 4 oz. Dispenser tubes
7020-3.....	11 oz. Caulking cartridges

LIQUID CERAMIC FOAM 2300°F

Pourable High Temp, Light Weight, Ceramic Shapes



Rescor 740 Base and Activator



Removing 740 Insulating Plate From Mold



Placing Heater Coils in Insulating Disk

RESCOR™ 740 - 2300°F LIQUID FOAM

*Easy to use "In House" Process Saves Time & Money
Just Mix, Pour and Harden Overnight For
Machinable, Thermally Insulating, Ceramic Parts*

Rescor 740 Liquid Foam forms lightweight, high strength, machinable, thermally and electrically insulating parts usable to 2300°F.

Easy to use "In House" process.

Just mix the ceramic powder with its liquid activator and pour into non- absorbent molds.

Hardens overnight to produce high strength, insulating prototypes and parts.

Can be used up to 2300°F with high temp. structural stability and excellent resistance to oxidizing and reducing atmospheres.

Resistant to molten non-ferrous metals, steam most chemicals and solvents.

Suitable for near net shape processing which involves casting a ceramic blank into a shape that requires minimal or no machining to final shapes.

Post curing Rescor 740 improves its machinability.

Applications include high temp. thermal and electrical insulators, heating element supports, hot pressing dies, processing boats, heat shields, fixtures, induction heating, etc.

User Reports

- Crucible supports, cast with Rescor 740, are used for glass melting furnaces replaced expensive custom made parts.
- Rescor 740 is used for pre-heater crucible liners in furnaces operating to temperatures as high as 1200°C.

Rescor Castable Ceramics are also available in Shock Resistant Liquid Silica, Ultra-Temp. Liquid Zirconia Oxide, Thermally Conductive Silicon Carbide and General Purpose, High Purity Liquid Alumina. See Pages 60 and 61 for details.

Physical Properties	740
Max. Use Temp.	2300°F
Density (# / ft. ³)	54
Shrinkage (%) 1000°F	1.00
Modules of Rupture (psi)	900
Compressive Strength (psi)	1500
Specific Heat (BTU / # °F)	0.24
Dielectric Strength (volts/mil)	100
Dielectric Constant (@ 10 ⁸ cps)	1.61
Thermal Expansion (x 10 ⁻⁶ / °F)	4.50
Thermal Conductivity (BTU in / Hr °F ft. ²)	
@ 500°F	1.00
@ 1000°F	1.50
@ 1500°F	1.80
Mix Ratio (by wt.) Powder	100 parts
Liquid	62 parts
Color	Tan
Shelf Life (Months)	6-9

Cat. No.	Description
Rescor 740-1.....	10 pound kit
Rescor 740-2.....	50 pound kit
Rescor 740-3.....	100 pound kit

See pg 62 for Mold Making Materials & Mold Releases

Cat. No.	Description
Replicast 101.....	Mold making material Gallon Kit
Replicast 101MR.....	Spray Mold Release 10 oz. Can

Quantity Prices on Request

RESCOR™ CER- CAST CERAMICS

Easy to use, Economical, Fast Setting and High Strength

Fused Silica - Zirconium Oxide - Silicon Carbide - Alumina

Rescor Castable Ceramics are available in 6 refractory compositions offering the ultimate selection of ceramics to the materials engineer.

Select from: Fused Silica, Zirconium Oxide, Silicon Carbide, Alumina and Low density Ceramic Foam.

Now, an unlimited number of high temperature applications, requiring custom ceramic shapes, can be easily solved.

Just mix the ceramic powders with their liquid activators and pour into any non-absorbent molds.

Rescor Castable Ceramics harden overnight to produce highly detailed ceramics, usable to 4000 °F.

They offer excellent resistance to high temperature, thermal shock, molten metals, oxidizing and reducing atmospheres, erosion, most acids and alkalis.



Casting an Alumina Furnace Tray



Pouring Rescor



Demolding

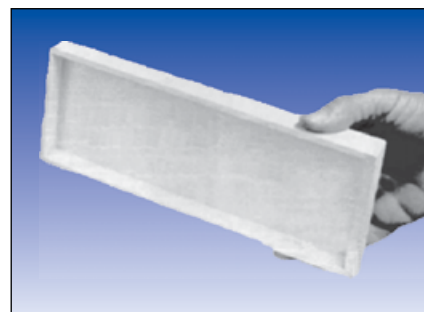

Alumina Furnace Tray

General Applications

- Electronics, thin film processing, coating, lighting, etc.
- Encapsulating, potting materials, resistors, wire winding forms, special applications, etc.
- Furnace parts, insulators, stand offs, burners, coil forms, ignitions, feed thrus, etc.
- Welding, soldering, brazing, etc.
- Processing, hot forming, glassing, sintering, etc.
- Welding nozzles, fixtures, jigs, etc.
- High temperature chemical reactors, furnace lining, corrosive atmospheres liners, cyclones, regenerators, incinerators, etc.
- Melting crucibles, nozzles, funnels, permanent casting molds, casting inserts, etc.

Users Report:

- Rescor 740 was used to cast cylindrical rings, 24" dia. x 2.5" high. They were machined to form precision thermally and electrical insulating rings for a casting furnace.
- Rescor 750 easily cast 2000 pound molds measuring 6 feet in length to be used for forming and curing composite materials.
- Rescor 780 moldings were used for quick tooling when casting White Metal bumper parts for automotive applications. Standard tooling would have delayed product introduction by many months.
- Rescor Castable Ceramics will satisfy many advanced requirements. They are ideal for "in house" fabrication of high strength parts and prototypes.

RESCOR™ CER- CAST CERAMIC

Easy to use, Economical, Fast Setting and High Strength

Fused Silica - Zirconium Oxide - Silicon Carbide - Alumina

Cat. No.	740	750	760	770	780	RTC-60
Description	Insulating Foam	Shock Resistant	Ultra Temp.	Corrosion Resistance	General Purpose	High Purity
Maximum Temp	2300°F	2700°F	4000°F	2700°F	3000°F	3250°F
Base	Al ₂ O ₃ -SiO ₂	SiO ₂	ZrO	SiC	Al ₂ O ₃	Al ₂ O ₃
Standard Grades Sample Castings						
Properties						
Density (# / ft ³) (in ³ /10 # kit)	54 223	110 157	250 69	145 119	180 96	175 98
Shrinkage (% as cast) % @ 1000°F	0.50 1.00	NIL 1.30	NIL 1.00	NIL 1.50	NIL 1.00	NIL 1.25
Compressive Strength (psi)	1,500	6,000	4,000	6,000	6,000	2,500
Modules of Rupture (psi)	900	1,500	1,200	1,500	1,800	1,000
Thermal Exp. (x10 ⁻⁶ /°F)	4.50	0.30	5.60	4.50	4	4
Thermal Cond. (BTU in/hr°F ²)	1	4	6.5	30	10	10
Dielectric Strength (volts/mil)	100	100	N.A.	N.A.	200	175
Volumetric Resistance (ohm-cm)	10 ⁹	10 ⁹	N.A.	N.A.	10 ⁹	10 ¹⁰
Moisture Resistance	Excellent	Excellent	Excellent	Excellent	Excellent	Excellent
Color	Tan	White	Tan	Black	White	White
Mix Ratio (base/activator)	100/64	100/28	100/18	100/24	100/24	100/10
Working Time (minutes)	20	20	20	20	20	25

Cat. No.	Description	lbs./Kit
740-1.....	Insulating Foam.....	10
740-2.....	Insulating Foam.....	50
740-3.....	Insulating Foam.....	100
750-1.....	Fused Silica.....	10
750-2.....	Fused Silica.....	50
750-3.....	Fused Silica.....	100
760-1.....	Zirconium Oxide.....	10
760-2.....	Zirconium Oxide.....	50
760-3.....	Zirconium Oxide.....	100
770-1.....	Silicon Carbide.....	10
770-2.....	Silicon Carbide.....	50
770-3.....	Silicon Carbide.....	100

Cat. No.	Description	lbs./Kit
780-1.....	Alumina Oxide.....	10
780-2.....	Alumina Oxide.....	50
780-3.....	Alumina Oxide.....	100
RTC-60-2*.....	Alumina Oxide.....	10
RTC-60-3.....	Alumina Oxide.....	Kit

(5 lbs. reg and 5 lbs. fine)

* For RTC-60 Specify Regular or Fine Grade Material

Mold Making Materials & Mold Release See pg 62 for Details

Cat. No.	Description	Size
101.....	Mold Making Material.....	Gallon Kit
101 MR.....	Mold Release (Spray-On).....	12 oz.
101MRCP.....	Case Pack of 12.....	12 oz cans
102MR.....	Mold Release (Paste).....	1 lb
103MR.....	Mold Release.....	16 oz.

(Pump-Spray-On)

PRECISION MOLD MAKING MATERIAL

REPLICAST™ 101

**Just Mix, Pour and Cure at Room Temp.
No Vacuum Degassing Required**



**Pouring Replicast
Around a Model**



**Replicast Mold
Ready For Casting**

Replicast 101	
Max Service Temp.	200°F
Density (gm/ cc)	1.39
Viscosity (cps)	4000
Hardness (Shore "A")	40
Tensile Strength (psi)	700
Tear Strength (psi)	90
Shrinkage (%)	0.05
Elongation (%)	700
Dielectric Strength (volts/mil)	200
Volume Resistivity (ohm-cm)	10 ⁹
Porosity	0.00
Color	Tan
Components	2
Cure Hrs (@ R.T.)	8 -16

Low cost, highly detailed, precision molds are easily produced with this simple mix and pour process.

Replicast 101 is non-toxic and virtually odor free.

No more vacuum degassing.

Just mix and pour.

Replicast 101 cures at room temperature.

Forms flexible, durable molds with high tear strength, dimensional stability, abrasion resistance and excellent mold life.

Ideal for mold making, tooling, components, coatings, seals, gaskets, tools, shock resistant parts, rollers, etc.

Use Replicast 101 with all of Cotronics' Ceramic and Epoxy Materials, Gypsum, Urethane, and Polyester Resins.

Users Report:

- Molds lasted for thousands of cycles when used to cast an intricate High Alumina welding and positioning fixture.
- Soft Rubber like parts and forms were easily cast to replace custom molded parts, eliminating costly time delays.

REPLICAST™ 101

**No-VOC'S - Non-Toxic - Non-CFC
Non - Combustable Mold Release**

Replicast	101MR	102MR	103MR
Max Temp.	625°F	100°F	150°F
Form	Spray Can	Paste	Pump Spray
Viscosity (cps)	500	250,000	50
Porosity	0.00	0.00	0.00
Color	Clear	White	Clear
Components	1	1	1
Cure (Mins. @ R.T.)	10-20	N/A	15-20
Package	18 oz.	1 Pint	16 oz.

Replicast 101 MR mold release is a non-greasy, non oily, film forming compound that can be used to 550°F.

Just spray on a lite coat.

Dries in minutes.

A super thin coating of 0.001 inch is all that is required even for the most demanding applications.

This ultra thin film allows for exceptional accuracy including the finest details of your parts.

Replicast 101 MR dries quickly for production applications.

Use with most Epoxies, Urethane, Ceramics and Heat Curing Systems.

101 MR should be used when casting molds with Replicast 101 Liquid Rubber insuring the finest details.

Replicast 102 MR is a smooth creamy paste for use with ceramics. Just wipe on a thin layer. Ideal for large castings.

Replicast 103 MR is specially designed for use when casting ceramics. Creates a smooth surface in the final ceramic parts.

Not for use with Epoxies.

Availability:

Cat. No.	Description	Price
Replicast 101-1.....	1 Gallon Kit	79.95/kit
Replicast 101 MR.....	12 oz. Can Mold Release	20.65/can
Replicast 101 MR-CP...	Case Pack 12 - Cans	223.00/case
Replicast 102 MR.....	Mold Release Grease Pint.....	16.95
Replicast 103 MR.....	Mold Release (Pump-Spray-On) 16 oz.	22.95/bottle



INSTRUCTIONS FOR ADVANCED CERAMIC CASTABLES

740, 750, 760, 770, 780, 310LF, RTC60 & RTC70

MOLDS

Replicast 101 Liquid Rubber is ideal for molds (see page 63, see below for directions for use).

If metal molds must be used, then design them with sufficient draft so that the cast ceramics can be removed.

Before casting apply a light coat of Spray on Mold Release 101MR. Can also use a thin coat of Paste Mold Release 102MR.

SHRINKAGE

Normal shrinkage will be very small and must be taken into account for all critical applications. See below for typical shrinkage values. (Actual values will vary with individual systems and mix ratios).

Cure Temperature	Typical Shrinkage (percent)	Typical Strength (modules of rupture)
Room Temp.	0.1 to 0.5	800 - 1200 psi
1000°F (535°C)	0.3 to 1.3	1000 - 2000 psi
1700°F (910°C)	0.5 to 2.0	1500 - 3000 psi
2500°F (1350°C)	1.0 to 2.5	3000 - 7000 psi

CERAMIC CASTING

Follow the detailed instructions on the product label. Use the specified base to activator weight ratio.

1. Using the weight ratio as specified on the product label, thoroughly mix the powder portion with its activator to form a thick paste-like consistency. For fine details 1% or 2% extra activator (by weight) can be used to increase fluidity. Working time is approximately 10 to 20 minutes.
2. Pour the ceramic mixture into the mold and work it into the corners. Overfill the mold slightly.
3. Vibrate the mold to remove air bubbles. (2-10 minutes should be sufficient).
4. After 20 minutes, remove any excess material with a trowel.
5. Cover the mold with a thin sheet of plastic and cure for 16-24 hours at room temperature.
6. After the room temperature cure, heat the ceramic casting for 2 hours at 225°F (110°C). This will remove any excess water and will provide additional strength.
7. A post cure at 1750°F (950°C) will increase the strength 2- 3 times. For parts under 1" thick heat the ceramic casting at a rate of 200°F per hour.
8. For thick castings (over 4" thick) request a special, slow curing instruction sheet.
9. HINT: Make a trial casting in a drinking cup (as a mold) before making the actual part. A trial part 2" dia. x 1" high is ideal. Heat treat the disc to check product shrinkage and strength before making critical parts.
10. NOTE: A thick paste like consistency is recommended for optimum strength and minimum shrinkage. A thick paste will flow when vibration is applied to the mold and container.
The Ceramic Castings will not out gas after it is fully cured.

Mold Making and Ceramic Casting Instructional CD's Available for \$14.95

INSTRUCTIONS FOR 101 MOLD MAKING MATERIAL

REPLICAST 101 can be used to make or repair flexible parts.

1. Machine an aluminum, plastic or other suitable pattern for use as a master. The pattern should be an exact duplicate of the part you wish to make. A good surface finish is desired.
2. Prepare a suitable container approximately ½" to 1" bigger than the master on all sides.
Coat the master and its container with Replicast 101 MR Mold Release. (Petroleum jelly may be used if 101MR is not available).
4. RE-STIR Replicast 101, some settling can occur in storage. **Use only metal stirring tools.**
5. Carefully weigh out 100 parts of Replicast 101 Resin to 10 parts of Replicast 101 Hardener.
HINT: The component's weight = total weight - weight of empty container.
6. Stir slowly and thoroughly, carefully scraping the side walls and bottom of the mixing container.
7. Hold the container of 101 (approximately 18" from the container holding the master) and pour the mixture in a thin stream.
8. Pouring slowly, in a thin stream, will allow the liquid rubber to de-gas and produce a void-free casting.

REMEMBER:

Mix slowly and thoroughly. (Do not whip air into mixture). Pour in a thin stream.

Do not introduce moisture into the un-mixed system.

Use REPLICAST 101 Mold Release for the best results.

CERAMIC ADHESIVE INSTRUCTIONS

INSTRUCTIONS

1. FOR NON-POROUS MATERIALS:

1. Clean surfaces. Remove old coating, adhesive, dirt, grease, etc.
2. De-grease with solvent such as **Resbond 105 RS** and dry thoroughly.

POROUS MATERIALS:

1. Clean surface of loose dirt and dust.
2. Moisten the surface to be bonded with a solution of 50% ceramic thinner and 50% clear water.
(Note: Use the thinner for the specific adhesive system selected).
2. **MIX ADHESIVE** thoroughly prior to use, follow directions on product label. **Do not whip air into the mix.**
NOTE: For two component systems, mix the powder and activator according to the weight ratio on the label.
3. **APPLY ADHESIVE** by spatula, brush or dipping. Completely wet the surfaces.
4. **IMMEDIATELY** press surfaces together. If necessary clamp or fix materials to maintain uniform distance while curing. Typically a gap of 0.01" to 0.02" is recommended. Excess adhesive can be removed with a damp rag.

CURING

1. Let joint air set 1- 4 hours.
2. Cure a minimum of 2 hours at 200°F (90°C).
3. Avoid excessively fast heating. It will cause adhesive to bubble and form a weak bond.

POST CURE

4. To Develop maximum strength, **solvent and moisture resistance.** Post cure for 1 hour at 250°F (120°C) followed by 1 hour at 600°F - 700°F (315°C - 370°C).
5. **NOTE:** Always follow the specific recommendations shown on the product labels. Consult the product label for instructions. Bond testing with sample pieces for your specific is applications recommended. Fast curing systems may be available for your specific needs. Contact Cotronics for recommendations.
6. **POTTING APPLICATIONS:** For potting applications request instructions for ceramic potting materials.
NOTE: these products will not out-gas after a complete cure.

EPOXY ADHESIVE INSTRUCTIONS

PREPARATION

1. Clean surfaces of all grease, oil, dirt, old coatings, rust, etc. Roughen surface to improve adhesion.
For best results use Resbond 105RS Solvent or Resbond Surface Prep 105RP.
2. Re-stir all Resins and Hardeners to insure a uniform, homogeneous product.
Warming resins to 100°F - 120°F (35°C -50°C) will reduce the viscosity and ease mixing.

MIX RATIO

3. All measurements are by weight. Follow instructions supplied on the product label for the exact mix ratios.
NOTE: Weight = (total weight) - (weight of container)
4. A. Weigh out the resin and the hardener into a separate clean container. Combine the resin and hardener. Mix slowly and thoroughly. Make sure to scrape the sides and walls of the container to insure a complete mix.
Do not whip air into the mix.
B. For single component systems re-mix, apply and heat cure as directed.

VACUUM DEGASSING

5. Special additives have been incorporated into COTRONICS' Epoxy systems to eliminate the need for vacuum degassing. Warming resin and letting the mixture stand several minutes before use will normally remove most of the remaining entrapped air. Vacuum degassing should be employed for critical applications.
NOTE: The use of warmed resin may reduce working time.

ADHESIVE APPLICATIONS

6. Apply with a trowel or with a dispensing syringe. Use Bond Lines from 0.005" - 0.010".
Disposable syringes are available from Cotronics.

POTTING AND CASTING APPLICATIONS

7. Pour slowly, in a thin stream, to allow the air to escape. The material should be allowed to flow around and under the components. **NOTE: A fast pour may trap air pockets.**

CURING

8. Follow the curing procedures listed on product labels for these systems.
Optimum high temperature properties are only obtained when following the recommended cure cycles.
9. Post cure for 4 hours at 200°F - 250°F (90°C -120°C) to enhance any room temp. curing system's properties.

CAUTION See MSDS for safety instructions. Mixing batches over 50-100 grams can create excessive heat in some systems.

Mixing and Measuring Adhesives

Re-stir all products before weighing or dispensing. Carefully weigh out the resins and hardeners separately, before mixing. (Use a minimum mix of at least 25 grams to insure a homogenous mixture) Mix thoroughly and completely before using. Improper measuring or mixing can cause materials not to cure, soft spots, air voids on the surface, sticky surfaces, softening at elevated temperatures, changes in chemical or electrical resistance.

Bonding Dissimilar Materials

Select an adhesive with a thermal expansion coefficient that closely matches the materials to be bonded. When possible select a flexible epoxy. Clean dirt, oils, greases and mechanically roughen the surfaces prior to bonding. Cure materials at room temperature and at 250°F.

Recommended Bond Line Thickness For Adhesive Bonding

For standard epoxy and ceramic adhesives a bond line thickness of 5-8 mils (0.005-0.008) will produce excellent results. For Cotronics' non-sag putties (epoxy or ceramic) bonds of 0.020 or more can be used. To form a thick layer or section apply putty in several layers curing between each application.

Joint Design and Bond Strength

Butt joints are usually the weakest, inserted joints (tongue and groove, rod into a tube provide a mechanical reinforcing) are the strongest. For repair and difficult applications use a metal or ceramic cloth buried in the glue line for additional reinforcing.

Bonding to Teflon, Nylon, Polyolefin and Similar Plastics

Specific surface treatments and/or etching are required for bonding these plastics. Cotronics' offers flexible and activated epoxies that form strong adhesive bonds to many of these difficult-to-bond materials.

Preventing Flow of an Adhesive From a Joint

Select an adhesive with high viscosity or with thixotropic properties and use just enough adhesive to completely fill the gap between the two surfaces to be bonded.

Thinning Adhesives for Application

Epoxy formulations can be thinned with mild heat or epoxy thinner 105RT to ease flow, create a thinner bond line or facilitate encapsulation.

Removing Bubbles in Potting Materials

You can reduce the amount of entrapped air by warming epoxies prior to application or by vacuum degassing. (Apply pressure of 29 in Hg for 2 minutes and then release).

Working With Electrically or Thermally Conductive Adhesives

Electrically and Thermally conductive adhesives will provide optimum results after a post cure for 2 hours at 250°F. Electrically conductive materials are also available in flexible versions to accommodate bonding substrates with different thermal expansions.

Cracking in Ceramic Adhesives and Castable Ceramics

Cracked and weak castings, encapsulations or adhesive bonds can occur when using ceramic materials if excess activator or additional water has been added to the uncured mixtures. Check the mix ratio that was used when mixing the materials.

Accelerating Cure Time

The best way to shorten the cure cycle is to raise the temperature. Typically most systems can be quickly cured at 250°F. One should check each products data sheet or label for specific instructions and recommendations.

Modifying Existing Formulations

Cotronics can adjust such formulations to provide variables as viscosity, gel time, curing characteristics as well as lap shear strength, peel strength, flexibility, chemical stability, heat resistance, impact strength color etc.

Special Packaging for Production Applications

Cotronics can supply materials in pre-measured units and in bulk quantities to facilitate the use of these systems in any production facility or field application.

USEFUL CONVERSION TABLES

VISCOSITY COMPARISON

Approx. Viscosity	Material
1.....	Water
10.....	Kerosene
100.....	Corn Oil
200.....	Maple Syrup
500.....	Castor Oil
1,000.....	Glycerin
3,000.....	Honey
10,000.....	Molasses
50,000.....	Ketchup
250,000.....	Peanut Butter
1,000,000.....	Shortening

TYPICAL COVERAGE FOR PUTTIES - ADHESIVES - COATINGS

Coverage (Ft ² /Qt.)	Film Thickness (inches)
300.....	0.001
150.....	0.002
100.....	0.003
60.....	0.005
45.....	0.007
30.....	0.010

BEAD LENGTH CHART

Half Round Bead Dispensed From a 11 oz. Caulking Cartridge

1/4"....80 ft.	1/2" ...21 ft.
3/8"....37 ft.	5/8" ...13 ft.

COMPARATIVE PARTICLE SIZE

Mesh	Microns	MM	Inches
4.....	4760.....	4.76.....	0.185
8.....	2380.....	2.38.....	0.093
16.....	1190.....	1.19.....	0.046
20.....	840.....	0.84.....	0.033
40.....	420.....	0.42.....	0.017
50.....	297.....	0.29.....	0.012
80.....	177.....	0.17.....	0.007
100.....	149.....	0.14.....	0.006
140.....	105.....	0.10.....	0.004
200.....	74.....	0.07.....	0.003
270.....	53.....	0.05.....	0.002
325.....	44.....	0.04.....	0.0017
400.....	37.....	0.03.....	0.0015

HARDNESS DUROMETER

Material	Shore A	Shore D
Gum Eraser.....	30
Pink Eraser.....	40
Rubber Stamp.....	50	15
Pencil Eraser.....	60
Rubber Heel.....	70	30
Rubber Sole.....	80
Typewriter Roller..	90
PVC.....	100	55
Fir Plywood.....	78
Hardwood.....	86
Glass.....	90

Conversion Factors

Area

$$\text{in}^2 \times 6.45 = \text{cm}^2$$

$$\text{ft}^2 \times 0.093 = \text{m}^2$$

Density

$$\text{lb} / \text{ft}^3 \times 16.02 = \text{kg}/\text{m}^3$$

$$\text{lb} / \text{in}^3 \times 0.016 = \text{g}/\text{cm}^3$$

Heat Loss

$$\text{Btu} / \text{hr ft}^2 \times 3.155 = \text{W}/\text{m}^2$$

$$\text{Btu} / \text{hr ft}^2 \times 0.271 = \text{g cal}/\text{hr cm}^2$$

Length

$$\text{in} \times 2.54 = \text{cm}$$

$$\text{in} \times 25.4 = \text{mm}$$

$$\text{ft} \times 0.3048 = \text{m}$$

Thermal Conductivity

$$\text{Btu in} / \text{hr ft}^2 \text{ F} \times 0.144 = \text{W}/\text{m} \text{ } ^\circ\text{C}$$

$$\text{W} / \text{m}^\circ\text{C} \times 6.93 = \text{Btu in}/\text{hr ft}^2 \text{ F}$$

Dielectric Strength

$$\text{Volts}/\text{mil} \times 0.039 = \text{Kv}/\text{mm}$$

Volume

$$\text{in}^3 \times 16.39 = \text{cm}^3$$

$$\text{in}^3 \times 0.0283 = \text{m}^3$$

Temperature

$$^\circ\text{C} = (5/9) (^\circ\text{F} - 32)$$

$$^\circ\text{F} = (9/5) (^\circ\text{C}) + 32$$

Weight

$$\text{lbs} \times 454 = \text{gm}$$

$$\text{lbs} \times 0.454 = \text{kg}$$

HIGH TEMP. MATERIALS INDEX

Hi-Temperature, Electronic and Industrial Applications

Cat. No.	Temp.	Description	Page
4B, 4BE.....		Braze Binder.....	40
007.....	450°F.....	Bond-IT, Quick Set Adhesive.....	14
56L.....	3000°F.....	Ultra Grade Graphite.....	56
101.....		Mold Making Material.....	62
101MR.....		Mold Releases.....	62
105.....		Epoxy Aids..... (Adhesion Promoters, Thinners, Solvents)	22
108.....		Disposable dispensers.....	22
112.....	3600°F.....	Boron Nitride Coating and Lubricant.....	37
120-127.....	500-650°F.....	Electrically Conductive Epoxies.....	10,11
126.....	450°F.....	One Component Silver Epoxy.....	16
128-135.....	500-600°F.....	Thermally Conductive Adhesives.....	12,13
201.....	1200°F.....	Liquid Aluminum Coating.....	36
201SP.....	1000°F.....	Aluminum Spray Coating.....	37
215.....	2500°F.....	Electrically Resistant Coating.....	36
230N.....	1500°F.....	Stainless Steel Heat and Corrosion Paint.....	36
254.....	1800°F.....	Stainless Steel Coating.....	36
300.....	3000°F.....	Ceramic Paper.....	43
310M.....	3000°F.....	Fused Silica Ceramic Foam.....	58
311.....	2300°F.....	Alumina Silica Ceramic Foam.....	58
360.....	3000°F.....	Ceramic Board.....	42
370.....	3000°F.....	Ceramic Blanket.....	42
372.....	3000°F.....	Moldable Sheets.....	44
375FT.....	2300°F.....	Thermal Stop Tapes.....	44
390.....	2500°F.....	Ceramic Fiber Tape.....	47
391.....	2600°F.....	Ceramic Tape and Cloth.....	48
395.....	2800°F.....	Thermeez Fiber Products.....	49
395R.....	1100°F.....	Braided Rope.....	50
396HT.....	2300°F.....	Insulating and Gasket Rope.....	50
397.....	1500°F.....	Thermeez Fiber Products.....	49
398.....	600°F.....	Kevlar - Aramid Products.....	46
399.....	2000°F.....	Silica Fiber Products.....	46
455.....	450°F.....	One Component Structural Adhesive.....	16
507TS.....	500°F.....	Thread Sealer.....	41
600.....	600°F.....	Glass Silicon Tape.....	40
620.....	600°F.....	Premium Teflon Tape.....	40
640.....	600°F.....	Double Sided Tapes.....	40
650.....	2000°F.....	Stainless Steel Foil Tape.....	40
740.....	2300°F.....	Liquid Ceramic Foam.....	59
740-780.....	4000°F.....	Rescor Cer-Cast Castable Ceramics.....	60-61
801-821.....	3200°F.....	Durapot Ceramic Casting Compounds.....	34,35
861-868.....	650°F.....	Durapot Epoxy Potting Compounds.....	20-21
901.....	2300°F.....	Ceramic Fiber Adhesive and Coating.....	51
901A.....	2300°F.....	Liquid Insulation Hardener.....	50
902.....	2100°F.....	Machinable Alumina Silicate.....	52
903HP.....	3250°F.....	Alumina Adhesive and Coating.....	26
904.....	4000°F.....	Zirconia Adhesive.....	32
905.....	2500°F.....	Quartz Adhesive.....	28
906.....	3000°F.....	Magnesia Adhesive.....	28
907.....	2300°F.....	All Purpose Fire Proof Adhesive.....	30
907GF.....	2300°F.....	Adhesive and Sealant Putty.....	38
907TS.....	2100°F.....	Threadlockers.....	41
908.....	3000°F.....	Alumina Adhesive.....	26
914.....	800°F.....	Machinable Glass Ceramics.....	57
915.....	1800°F.....	Macor Glass Ceramics.....	56
919.....	2800°F.....	Electrically Resistant Adhesive.....	29
920.....	3000°F.....	Thermally Conductive Adhesive.....	29
931.....	5400°F.....	High Purity Graphite Adhesive & Coating.....	32

Cat. No.	Temp.	Description	Page
940.....	2000°F.....	Fast Set, Zircon Based Adhesive.....	31
940HT.....	2800°F.....	Fast Set, Alumina Adhesive.....	31
940LE.....	2500°F.....	Low Expansion, Fast Set, Ceramic Adh.....	31
950.....	1200°F.....	Aluminum Adhesive and Putty.....	33
952.....	2000°F.....	Nickel Adhesive and Putty.....	33
954.....	2000°F.....	Stainless Steel Adhesive and Putty.....	33
960.....	3000°F.....	Machinable Alumina.....	55
961.....	3100°F.....	High Strength Alumina Ceramic.....	54
962.....	500°F.....	Low Expansion, Borosilicate Glass.....	54
970N.....	3000°F.....	Resbond Ceramic Adhesives Selector Kit.....	25
989.....	3000°F.....	Alumina Adhesive.....	27
989F.....	3000°F.....	Ultra fine, Alumina Adhesive.....	27
989FS.....	3000°F.....	Fast Setting, Alumina Adhesive.....	27
1529.....	1800°F.....	High Temp. Sealers.....	36
1531-1533.....	800°F.....	Silicones.....	23
4400.....	400°F.....	Thermally Conductive Adhesive.....	14
4420.....	450°F.....	Single Component Epoxy.....	16
4460.....	600°F.....	Low Viscosity Adhesive.....	6
4461.....	500°F.....	Low Viscosity Epoxies.....	7
4463.....	500°F.....	Low Expansion Adhesive.....	15
4525.....	500°F.....	Electrically Resistant Epoxy.....	5
4538.....	450°F.....	Super Flexible Epoxy.....	9
4540.....	500°F.....	Liquid Aluminum Epoxy.....	17
4700.....	600°F.....	Ultra Temp. Epoxy.....	8
4703.....	700°F.....	Adhesive and Tooling Compound.....	8
6105.....	1200°F.....	Brush On Stainless Paint.....	37
6105SP.....	1200°F.....	Stainless Paint.....	37
7011.....	3000°F.....	Thermal Boards.....	40
7020.....	3000°F.....	Ceramic Putty.....	51
7025.....	1000°F.....	Aluminum Putty.....	39
7030.....	1800°F.....	Epoxy Like Adhesive.....	30
7032.....	2000°F.....	Stainless Steel Putty.....	39
7050.....	400°F.....	Nylon Bonder.....	15
7056AL.....	450°F.....	Super Fast Set, Aluminum Adhesive.....	17
Epox-Eez.....	450-600°F.....	Pre-measured Kits.....	19
Epox-Eez.....	450-500°F.....	Twin Pack Cartridges.....	18
NM 25.....	500°F.....	Non Magnetic Adhesives.....	14
R-450.....	2400°F.....	Anti-Seize.....	37
RK454.....	500°F.....	Epox-Eez Repair Kits.....	39
RTC 60.....	3250°F.....	Castable Alumina.....	61
S5H13.....	500°F.....	Sterilizable Epoxy Adhesive and Sealant.....	15
T507.....	500°F.....	Teflon Coating.....	17

INSTRUCTIONS

Description	Page
Castable Ceramics.....	63
Mold Making Materials.....	63
Adhesive Guidelines.....	64

PROPERTY TABLES

Duralco Epoxy Adhesives.....	4
Durapot Ceramic Potting Compounds.....	34
Durapot Epoxy Potting Compounds.....	20
Resbond Ceramic Adhesives.....	24
Rescor Machinable Ceramics.....	52
Rescor Castable Ceramics.....	61

INSTRUCTIONS

Conversion Tables.....	66
Hints and Tips.....	65
Table of Contents.....	3
Terms and Conditions.....	2

HIGH TEMPERATURE MATERIALS HANDBOOK

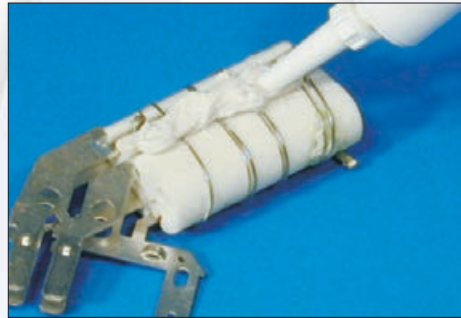
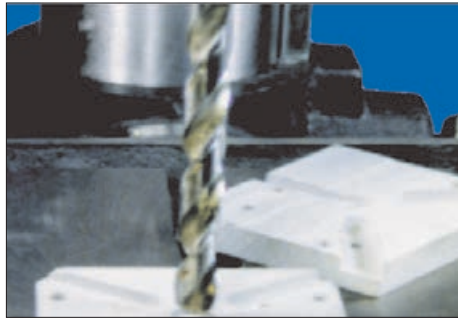
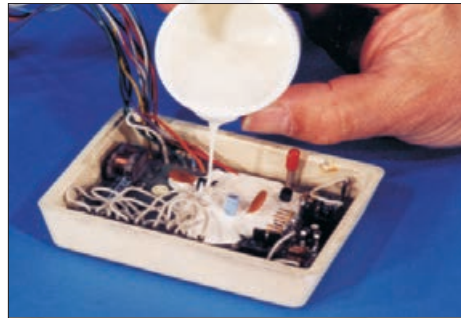

COTRONICS CORP.

131 47th Street, Brooklyn, N.Y. 11232

FIRST CLASS MAIL



VISIT OUR WEB SITE www.cotronics.com